

ZLINE

ATTAINABLE LUXURY[®]

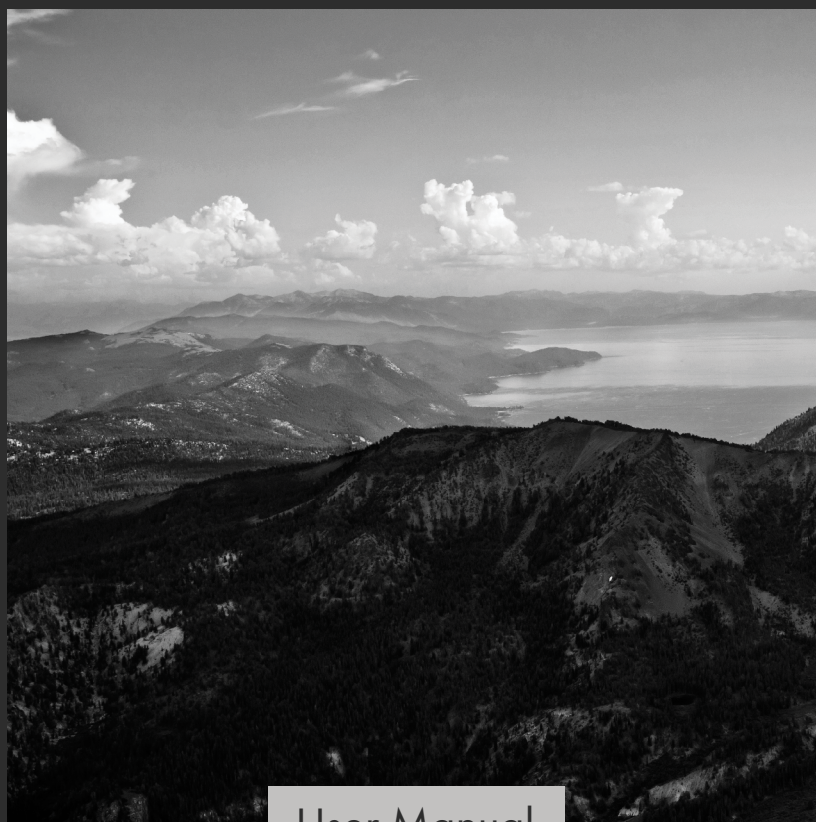

User Manual

CLASSIC DISHWASHER

www.zlinekitchen.com



ZLINE Kitchen and Bath provides Attainable Luxury, where the kitchen and bath of your dreams is never out of reach. Through our unique designs and unparalleled quality, we're dedicated to providing you an elevated experience in the heart of your home. With an endless selection of features and finishes, our inspiration is your reality.

ZLINE
ATTAINABLE LUXURY®



ZLINE is fueled by a passion for innovation; A relentless pursuit of bringing the highest end luxury designs and professional features into everyone's homes. Because we continually strive to improve our products, we may change specifications and designs without prior notice.

⚠ WARNING: This product can expose you to chemicals including nickel, which is known to the State of California to cause cancer. For more information, go to www.P65Warnings.ca.gov.

TABLE OF CONTENTS

IMPORTANT SAFETY INSTRUCTIONS	1
OPERATION	4
MAINTENANCE AND CLEANING	18
TROUBLESHOOTING	20
WARRANTY	25

IMPORTANT SAFETY INSTRUCTIONS

Throughout this manual, you'll see Warning and Caution notes. These warnings, cautions, and important safety instructions do not cover all possible conditions and situations that may occur. It's your responsibility to use common sense, caution, and care when installing, maintaining, and operating the dishwasher. ZLINE is not liable for damages resulting from improper use or installation.

NOTE: These warning signs are here to prevent injury to you and others. Please follow them explicitly. After reading this manual, keep it in a safe place for future reference.

IMPORTANT SAFETY INSTRUCTIONS



Hazards or unsafe practices that may result in severe personal injury or death.



Hazards or unsafe practices that may result in personal injury or property damage.



To reduce risk of fire, explosion, electric shock, or personal injury when using the dishwasher, follow these basic safety precautions.



Make sure the machine is grounded to prevent electric shock.

- Installation and repair should be performed by a qualified installer, such as an insured licensed plumber or contractor. Installation performed by non-professionals could be dangerous and result in improper installation and property damage, which may void the warranty.
- Install and store the dishwasher inside, away from exposure to weather



Do not install the dishwasher near electrical components. Keep the dishwasher away from open flames.

IMPORTANT SAFETY INSTRUCTIONS

PROPER INSTALLATION

- Please have a professional install your dishwasher properly by following the instructions included in the installation manual provided with this appliance.
- Do not install the dishwasher on a carpet, as this is a fire hazard.
- Do not install the dishwasher in a location where the water may freeze (where the temperature falls below 32°F). Frozen water in the hoses or pipes may damage the dishwasher.
- The water supply inlet temperature should be between 120°F and 149°F.
- Dispose of all packing materials for this appliance properly.
- The dishwasher must be properly grounded or it can result in a risk of electric shock. A permanent electrical connection is allowed.
- Do not operate the appliance if it's damaged, malfunctioning, partially disassembled, or has missing or broken parts. If the unit arrives damaged, contact ZLINE at 1-614-777-5004 for help.

BASIC PRECAUTIONS BEFORE USE

- Read all instructions and precautions in both this user manual and the provided installation manual before using the dishwasher.
- Please note this user manual does not cover every possible condition and situation that may occur. A qualified technician or plumber must install the product.
- Use the dishwasher only for the intended functions described in this manual.
- When loading dishes and other items to be washed:
 - Load sharp items and knives so they do not damage the door seal and tub.
 - Load sharp items and knives with the handles up to reduce the risk of injury.
- Do not wash plastic food storage receptacles (e.g. Tupperware) or other items unless they are marked dishwasher-safe. If they are not marked, check with the manufacturer for recommendations, as items that are not dishwasher-safe may melt and create a potential fire hazard.
- If the dishwasher drains into a food/garbage disposal, make sure the disposal is completely empty before running the dishwasher.

IMPORTANT SAFETY INSTRUCTIONS

- Do not tamper with the control panel on the dishwasher.
- Do not operate your dishwasher unless all enclosure panels are in the proper place.
- Do not touch the heating element during or immediately after any washing, sanitizing, or drying cycle to reduce the risk of injury.
- To reduce the risk of injury, do not allow children to play in or on a dishwasher. Keep young children and pets away from the dishwasher when it is operating. Do not let children abuse, sit, or stand on the door or racks of the dishwasher.
- Do not use the dishwasher if it has a damaged power line or plug. Do not plug the dishwasher into a damaged outlet. Failure to observe these instructions may result in electrical shock or death.
- Use only detergents or rinse agents recommended for use in a dishwasher. Keep them out of the reach of children and away from pets.
- Some dishwasher detergents are strongly alkaline. They can be extremely dangerous if swallowed. Avoid contact with the skin and eyes and keep children away from the dishwasher when the door is open.
- Under certain rare conditions, hydrogen gas may be produced in a hot water system that has not been used for two weeks or more. If the hot water system has not been used for such a period, before using the dishwasher, turn on all hot water faucets and let water flow from each for several minutes. This will release any accumulated hydrogen gas. Hydrogen gas is flammable. Do not smoke or use an open flame during this time to reduce risk of fire, injury, or death.
- Do not store or use combustible materials, gasoline, or other flammable vapors and liquids in the vicinity of this or any other appliance.
- Remove the door to the washing compartment when removing an old dishwasher from service or discarding it.
- This dishwasher is intended for residential use only and should not be used in commercial establishments. This appliance is not applicable for outdoor usage. The manufacturer disclaims responsibility for damage or injury caused by improper use of this appliance.



For your safety, please follow the information in this manual to minimize the risk of fire, explosion, electric shock, and to help prevent property damage or personal injury.

OPERATION

ELECTRIC SHOCK HAZARD

- As with all equipment using electricity, water, and moving parts, potential hazards exist. To safely operate this appliance, become familiar with its operation and exercise care when using it.
- The dishwasher must be properly grounded by a professional technician. Never connect it to an ungrounded outlet. Follow the instructions included in the installation manual for this appliance.
- Do not use an extension cord for this appliance.
- To reduce the risk of electric shock, fire, or injury to persons, the installer must ensure that dishwasher is completely enclosed at the time of installation.
- Only connect the dishwasher to the power supply when all installation and plumbing work is complete. Before installation or service, disconnect the power supply to the work area by unplugging the unit, “tripping” the circuit breaker, or removing the fuse.



Do not use the dishwasher until it is correctly installed. Do not push down on the door when it is open. Do not place excessive weight on the open door.

WATER CONNECTION SAFETY

- Make sure the professional installing your dishwasher uses a new water supply line. Old lines are susceptible to breakage because they become hardened and may cause property damage due to a water leakage.
- The dishwasher must be connected to a hot water supply with a temperature between 120°F and 149°F. This temperature range provides the best washing result and shortest cycle time. Temperature should not exceed 149°F to prevent damage to dishes.
- Ensure that the water supplied to the dishwasher does not freeze. Frozen water can damage the hoses, valves, pump, or other components.
- Ensure that there are no visible water leaks during and after the first use of the appliance.
- To avoid risk of injury, always use caution when opening the door during or following a wash cycle, as hot water or steam may escape.

OPERATION

NOTE: Specifications are subject to change without any notice for quality improvement purposes. The actual appearance of the dishwasher may differ from the illustrations in this manual.

SPECIFICATIONS FOR MODEL DW7714-18	
Capacity	Up to 8 place settings
Dimensions (W x D x H)	17 5/8" x 22 3/8" x 32 1/2"
Power Supply	120 VAC, 60 HZ
Rated Power Usage	Wash motor: 100W
	Heater: 700W
Water Feed Pressure	20 PSI - 145 PSI
Inlet Water Temp	120°F - 149°F

SPECIFICATIONS FOR MODEL DW7713-24	
Capacity	Up to 10 place settings
Dimensions (W x D x H)	23 9/16" x 22 3/8" x 32 1/2"
Power Supply	120 VAC, 60 HZ
Rated Power Usage	Wash motor: 100W
	Heater: 700W
Water Feed Pressure	20 PSI - 145 PSI
Inlet Water Temp	120°F - 149°F



ZLINE's exclusive integrated EcoWash technology and EnergySave functionality determine the most environmentally conscious cycle based on the load size and soil level. Each cycle reduces water consumption by up to 30% while delivering optimal cleaning results.

OPERATION

SPECIFICATIONS FOR MODEL DW7714-18	
Capacity	Up to 8 place settings
Dimensions (W x D x H)	17 5/8" x 22 3/8" x 32 1/2"
Power Supply	120VAC, 60 HZ
Rated Power Usage	Wash motor: 100W
	Heater: 700W
Water Feed Pressure	20 PSI - 145 PSI
Inlet Water Temp	120°F - 149°F

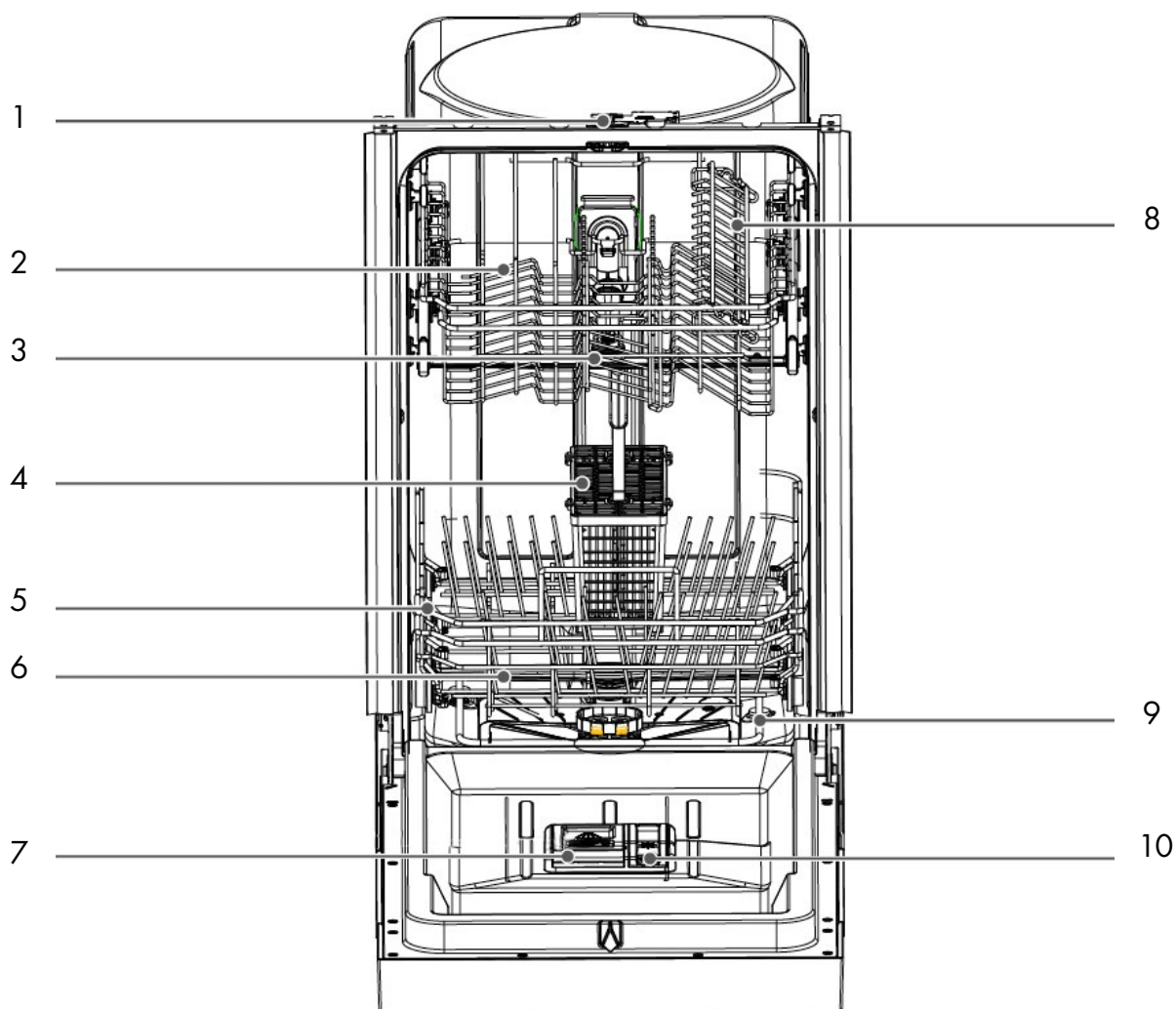

- | | |
|-------------------|------------------------|
| 1 Lock | 6 Lower Spray Arm |
| 2 Upper Basket | 7 Detergent Dispenser |
| 3 Upper Spray Arm | 8 Cup Shelf |
| 4 Cutlery Basket | 9 Heating Element |
| 5 Lower Basket | 10 Rinse Aid Dispenser |

OPERATION

SPECIFICATIONS FOR MODEL DW7713-24	
Capacity	Up to 12 place settings
Dimensions (W x D x H)	23 9/16" x 22 3/8" x 32 1/2"
Power Supply	120VAC, 60 HZ
Rated Power Usage	Wash motor: 100W
	Heater: 700W
Water Feed Pressure	20 PSI - 145 PSI
Inlet Water Temp	120°F - 149°F

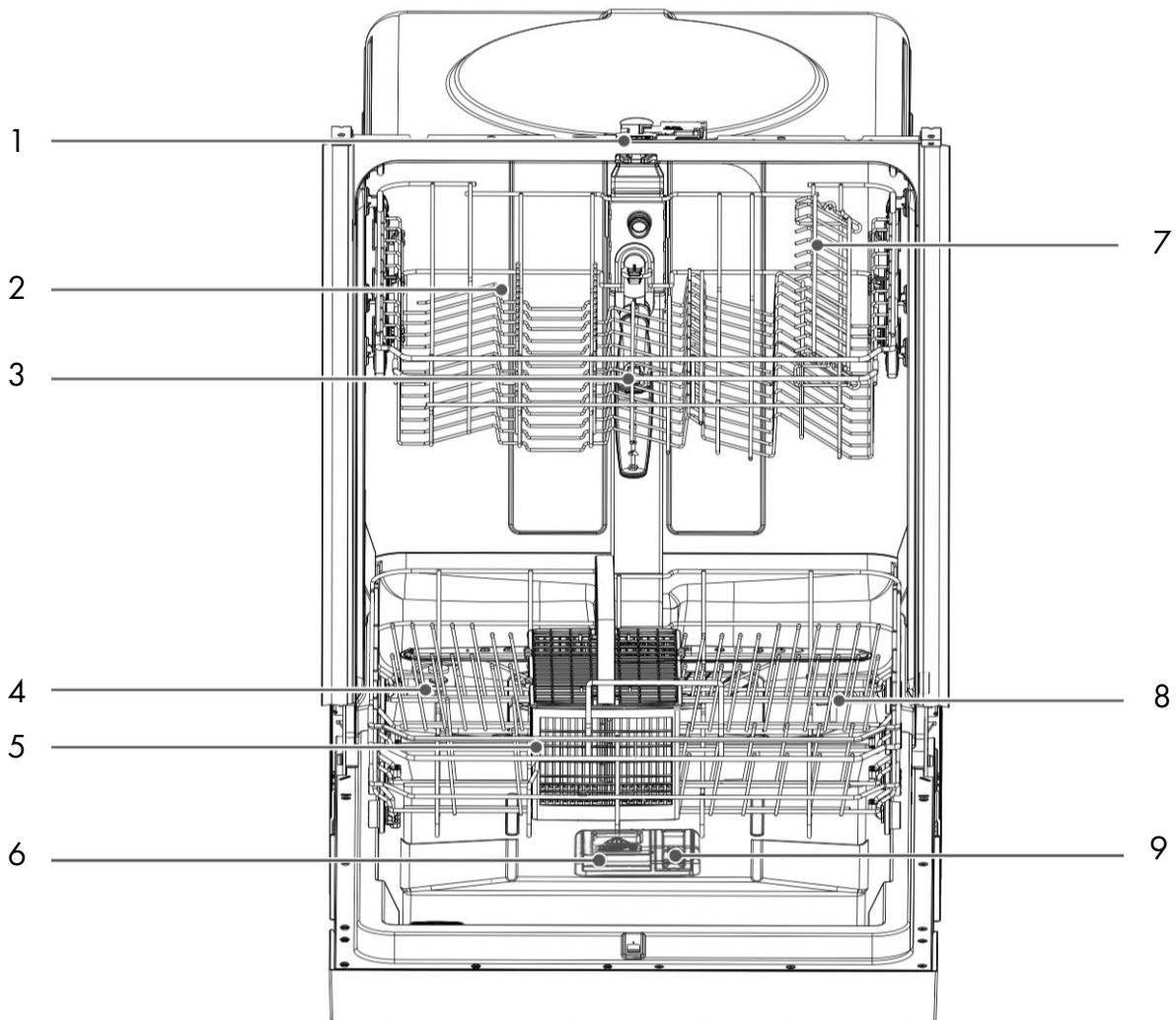

- 1 Lock
- 2 Upper Basket
- 3 Upper Spray Arm
- 4 Cutlery Basket
- 5 Lower Basket
- 6 Detergent Dispenser
- 7 Cup Shelf
- 8 Heating Element
- 9 Rinse Aid Dispenser

OPERATION

FILTER SYSTEM

Your dishwasher has a multiple filter system. In the system, there are three mesh filters.

- It can separate soiled water and clean water in different chambers.
- The system helps your dishwasher get better performance with less water and less energy. See page 19 for how to clean the filters.

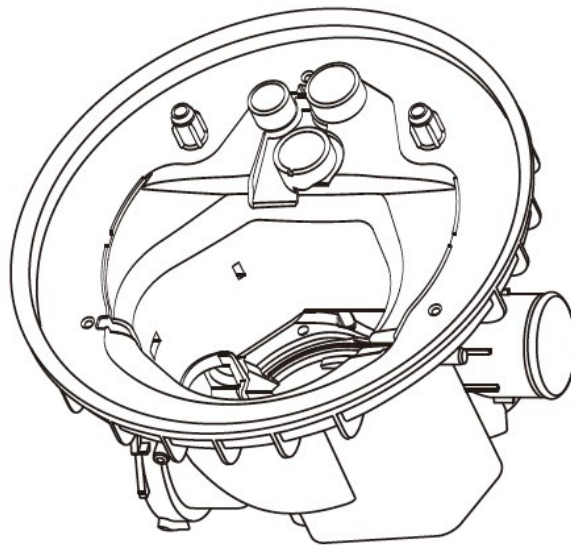

SMART WASH SYSTEM

- Your dishwasher has a smart wash system. When a partial load of lightly soiled dishes is placed in the unit, a wash cycle similar to a short wash will automatically be performed.
- When a full load of heavily soiled dishes is placed in the unit, a heavy wash cycle will automatically be performed. The appliance can determine the type of cycle required to clean the dishes and will clean more efficiently every time.

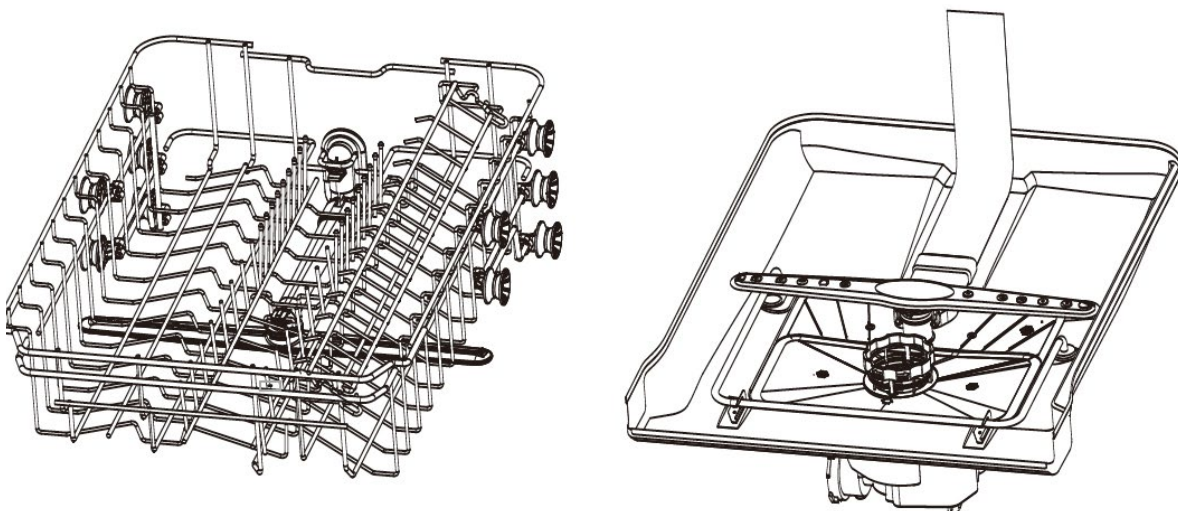

OPERATION

HOW YOUR DISHWASHER CLEANS

- Your dishwasher cleans by spraying a mixture of hot water and detergent through the spray arms against soiled surfaces.
- The dishwasher fills with water covering the filter area. Water is then pumped through the multiple filter system and spray arms. Separated soil particles go down the drain as the water is pumped out and replaced with clean water.
- The number of times water fills inside the tub will vary with the cycle being used.

WASH CYCLE SELECTIONS

- Cycle times are approximate and will vary with the options selected. Hot water is necessary to activate the detergent and melt fatty food soils.
- An automatic sensor will check the incoming water temperature. If it is not at the appropriate temperature, the timer will delay the cycle to allow automatic water heating during the main wash.
- When the HI-TEMP wash is selected, an even higher water temperature will be activated to handle heavier soil loads.

GETTING STARTED

1. Load the dishwasher (see Dish Preparation and Loading sections, pages 14-16).
2. Add detergent (see Filling the Detergent Dispenser, page 17).
3. Add rinse aid (see Filling the Rinse Aid Dispenser, page 17).
4. Select desired CYCLE (see Cycle Chart, page 13).
5. Select desired OPTIONS (see Control Panel, page 10). The indicator light above the pad will glow when selected.
6. To start, press start/cancel (see Control Panel). Then close door

Note: Your dishwasher has the controls mounted on the front of the door. The door must be closed first if you want to operate the appliance.

OPERATION

CONTROL PANEL

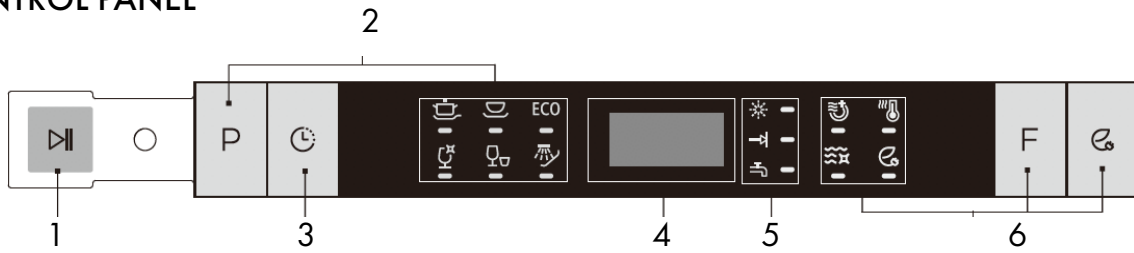

1. Start/Pause

- Open the door to select the desired cycle and options, touch the Start/Pause button, and close the door within 4 seconds to start the cycle or begin the delay countdown.
- To cancel and reset the program during the cycle, open the door and touch Start/Pause for 3 seconds. Close the door, and the dishwasher will start a 60 second drain.
- In the event you need to cancel the desired function, the Start/Pause button also serves as the cancel function. Press and hold Start/Pause for 3 seconds to cancel the cycle.

2. Wash Cycle Selections

P - Program Buttons

Touch to select the program; the corresponding indicator will light up.



H - Heavy

This cycle is for hard-to-clean, heavily soiled dishes, pots, pans, and dishes.



N - Normal

This is the standard program for regularly soiled dinner dishes or silverware.



E - ECO

This program is suitable to clean normally soiled tableware and is the most efficient program in terms of its combined energy and water consumption for that type of tableware.



G - Glass

For lightly soiled loads, such as glasses, crystal, and porcelain dishes.



R - Rapid

A shorter wash for lightly soiled loads that do not need drying.



R - Rinse

Use for rinsing dishes, glasses, and silverware that will not be washed right away.

OPERATION

3. Delay

- To delay the start of a selected cycle, press the delay start pad until the desired delay time shows in the LED display. You can delay the start for 1 to 24 hours.
- To cancel the delay start option before the delay period is over, press the start/cancel pad for 3-5 seconds.

4. Display Window

This displays the remaining hours and minutes of the running cycle, delay hours, error codes, etc.

NOTE: The displays stay on during operation of each cycle.

5. Status Indicators



R - Rinse aid needs to be refilled.



P - Program end.



N - Incoming water fault; check incoming water supply

6. Options



H - Heating Dry

When the Heating Dry function is selected, the heater will work during the dry process.



S - Sanitize

When the Sanitize function is selected, the temperature of water will be maintained at 156.2°F max. The max temperature may not be reached if the incoming water temperature is not correct. Certified residential dishwashers are not intended for licensed food establishments.

NOTE: The sanitize option is available with Heavy, Normal, and ECO cycles.

OPERATION



H - Hi Temp

When the Hi Temp wash function is selected, the temperature of the water will be maintained at 140°F max.

NOTE: The Hi Temp option is available with Heavy, Normal, ECO, and Glass cycles.



E - Energy Save

When the Energy Save function is selected, energy consumption will be reduced during the washing process.

Note: The Energy Save option is available with Heavy and Normal cycles.

STATUS WINDOW

H:01 - H:24

If the delay start option is selected, the number of delay start hours shows in the status window.

2:25 - 0:00

After the machine starts operation, the remaining time of the selected cycle will be shown in the window.

ERROR INDICATION

- In certain situations that are critical to dishwasher function and safe operation, the appliance will shut down and indicate an error code (see Troubleshooting, page 20).
- If error codes are displayed and troubleshooting measures are unsuccessful, contact ZLINE Customer Service at 1-614-777-5004 for help. We will be able to provide assistance in troubleshooting the problem and/or locate an authorized service technician if needed.

NOTE: The remaining time could suddenly increase or drop several minutes. This means the smart sensor has checked the soil level and determined if additional water fills are needed or if water fills can be deleted.

OPERATION

CYCLE CHART			
PROGRAM	DESCRIPTION OF CYCLE	WATER (L OR G)	CYCLE TIME (MIN)
Heavy	Pre Wash Main Wash (140°F) Rinse (149°F)	19.7 Liters	155
	Rinse with Sanitize (156.2°F) Drying	5.2 Gallons	
Normal	Pre Wash Main Wash (122-131 °F) Rinse (136.4-140°F)	9.5-18.5 L	105-135
	Rinse with Sanitize (156.2°F) Drying	2.5-4.9 G	
ECO	Pre Wash Main Wash (113-122°F) Rinse (122-131 °F)	15.5 L	105
	Rinse with Sanitize (156.2°F) Drying	4.1 G	
Glass	Pre Wash Main Wash (118.4-122°F) Rinse (122-131 °C)	15.5 L	95
	Drying	4.1 G	
Rapid	Pre Wash Main Wash (122°F) Rinse (131 °F)	15.5	60
		3.3 G	
Rinse	Pre Wash Main Wash (122°F)	6.7 L	20
		1.8 G	

Note: Your dishwasher has the controls mounted on the front of the door.

The door must be closed first if you want to operate the appliance.

OPERATION

DISH PREPARATION

- Prior to loading the dishwasher, scrape away large pieces of food, bones, pits, toothpicks, etc. The continuously filtered wash system will remove remaining food particles.
- Burned-on foods should be loosened before loading. Empty liquids from glasses and cups.
- Foods such as mustard, mayonnaise, vinegar, lemon juice, and tomato-based products may cause discoloration of stainless steel and plastics if allowed to sit for a long period of time. Unless you plan to run the dishwasher immediately, it is best to rinse off these food soils.
- If the dishwasher drains into a food/garbage disposal, be sure the disposal is completely empty before starting dishwasher.

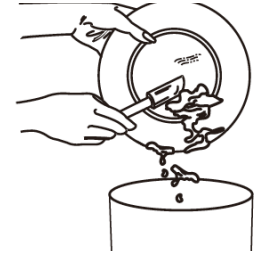

LOADING THE UPPER BASKET

- The upper basket is designed for cups, glasses, small plates, bowls, and plastic items marked dishwasher-safe.
- For best results, place the bowls, cups, glasses, and sauce pans with soiled surfaces facing down or toward the center. Tilt slightly for better drainage.

LOADING THE LOWER BASKET

- The lower basket is designed to load plates, soup bowls, plates, saucers, and cookware. The adjustable basket space will allow you to load items with a maximum height of 11".



WARNING

- Make sure the loaded dishes do not interfere with the rotation of the middle spray arm, which is located at the bottom of the upper basket (check this by rotating the middle spray arm by hand).
- Large items should be placed along the edge so they do not interfere with the middle spray arm rotation. Make sure they do not prevent the detergent dispenser from opening.
- Large items should be turned so the inside faces downward. Make sure these items do not interfere with the lower spray arm rotation.

OPERATION

LOADING THE LOWER BASKET

- The lower basket is especially designed for dinner dishes, soup bowls, plates, pots, lids, casserole dishes, and plates.
- Load large items such as pans and pots so their open sides face downwards. We recommend loading cups, stemware, and small plates in the upper basket.

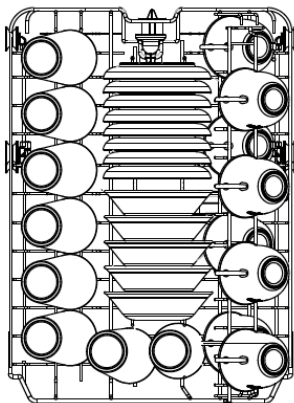

Model DW7714-18
8 place settings

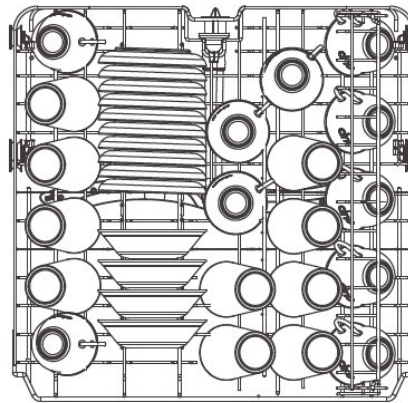

Model DW7713-24
10 place settings

LOADING THE UPPER BASKET

- The upper basket has been designed for small plates, mugs, glasses, and plastic items marked dishwasher-safe. Load plates in two half rows so the front of each plate faces the back of the plate in front of it, and the open sides of the plates at the center of the dishwasher face each other.
- Make sure loaded dishes do not interfere with the rotation of the spray arm located at the bottom of the upper basket (check this by rotating the nozzle by hand).
- When loading dishes, pull the upper basket out completely so you can load it without striking the counter.

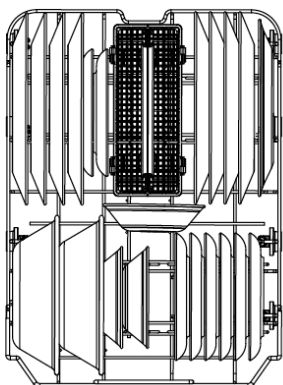

Model DW7714-18
8 place settings

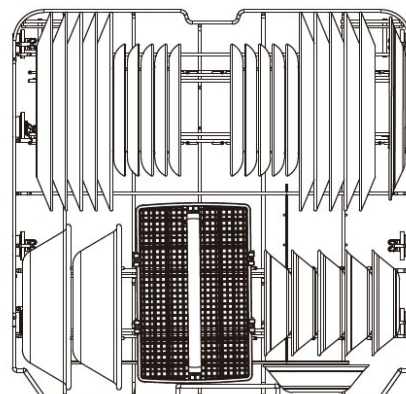

Model DW7713-24
10 place settings

OPERATION

LOADING THE SILVERWARE BASKET

- The silverware basket can be divided into three separate modules that can be used in both upper and lower racks.

1. Spoons
2. Knives
3. Salad Forks
4. Forks
5. Large Spoons
6. Large Forks

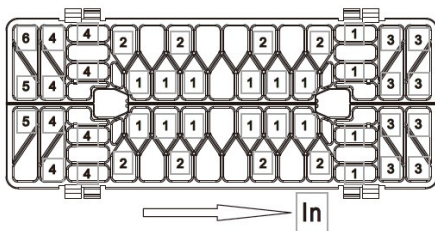

Model DW7714-18
8 place settings

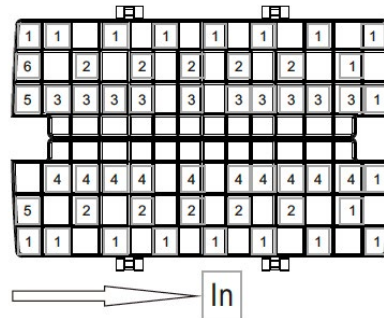

Model DW7713-24
10 place settings



Do not let items extend or protrude through the bottom of the basket to avoid blocking the spray arm.

ADDING DISHES MID-CYCLE

To add or remove items after a wash cycle starts:

1. Open the door slightly and wait a few seconds until wash action stops completely before opening.
2. Add/remove the item(s).
3. Close the door firmly to latch within 4 seconds and the cycle will resume.



TO AVOID BURNS OR OTHER INJURY: Slightly open the door and wait until spray arms and wash action fully stop. Hot water may splash out of the dishwasher. Failure to do this may result in injury.



Use caution to not overload or stack dishes in the upper, lower or silverware baskets, as items may not clean or dry properly.

OPERATION

FILLING THE DETERGENT DISPENSER

1. Open the detergent dispenser cap by pushing the detergent dispenser release button. **NOTE:** The flap should always open at the end of a dishwashing cycle.
2. Add the recommended amount of detergent to the main wash detergent compartment.
3. Close the flap and then press it down until it clicks shut.

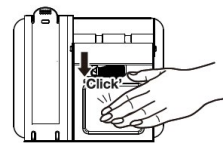
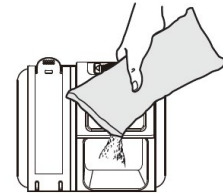
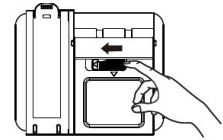

FILLING THE RINSE AID DISPENSER

- Rinse aid greatly improves drying and reduces water spots and filming. Without rinse aid, your dishes and dishwasher interior will have excessive moisture.
- The heated dry option will not perform as well without rinse aid. The rinse aid dispenser, located next to the detergent cup, automatically releases a measured amount of rinse aid during the last rinse.
- If the rinse aid is low, the rinse aid light is illuminated at the beginning and end of the cycle, indicating that it is time to refill.
- **NOTE:** While rinse aid will assist in the drying process, the dishwasher is not designed to completely dry every dish. Some water will naturally accumulate in items that have reservoirs, such as plastic containers and the bottom of coffee mugs. This is a normal occurrence in nearly all dishwasher models.



WARNING

Your dishwasher is designed to use a liquid rinse aid. The use of rinse greatly improves drying performance after the final rinse. Do not use a solid or bar-type rinse aid. Under normal conditions, the rinse aid will last approximately one month. It is best to keep it full, but do not over fill.

MAINTENANCE AND CLEANING

FILLING THE RINSE AID RESERVOIR

- Your dishwasher has been designed to use liquid rinse aid only.
- Using a powdered rinse aid will clog the reservoir opening and cause the dishwasher to malfunction.
- Rinse aid improves the drying performance of the dishwasher.



Do not add regular detergent to the rinse aid reservoir. Do not fill the reservoir above the full level indicator. Excess rinse aid can overflow during the wash cycle.

1. Remove the rinse aid reservoir cap by rotating it counterclockwise.
2. Fill the rinse aid reservoir with rinse aid.

Use the viewing port when filling the rinse aid reservoir.

3. Add the rinse aid if the display screen shows "LSb".

4. Close the rinse aid reservoir cap by rotating it clockwise. Keeping your dishwasher clean improves its performance, reduces unnecessary repairs, and lengthens its life.

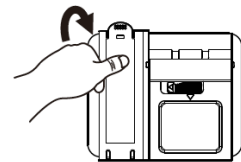
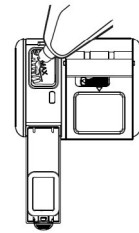
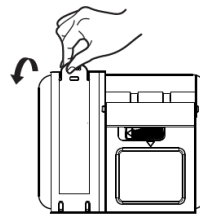

MAINTENANCE AND CLEANING

CLEANING THE EXTERIOR

- It's best to clean spills on the outside of your dishwasher as they occur. Use a soft, damp cloth on the control panel to gently wipe away spills and dust.
- Do not use benzene, wax, thinner, chlorine bleach, or alcohol. These materials may discolor the inner walls and cause stains.
- Do not clean the dishwasher by sprinkling or spraying water over it and avoid letting water come into contact with any of the electrical parts.
- If your dishwasher has a stainless steel door panel, you can clean it with a stainless steel cleaner for home appliances or a similar product using a clean, soft cloth.

CLEANING THE INTERIOR

- Clean the interior of your dishwasher periodically to remove any dirt or food particles. Wipe the inside of the dishwasher and the inner part of the door with a wet dishcloth.
- We recommend filling the detergent dispenser with dish detergent and then running the dishwasher empty periodically using either the Normal or Rapid cycle with the sanitize option. This will keep your dishwasher clean.
- If white spots and odor are still present in your dishwasher, run the Normal cycle with the dishwasher empty and without detergent until it flushes. Then, interrupt the cycle and put an 8-ounce cup of white vinegar into the lower basket. Close the dishwasher and let the cycle finish.



Do not remove the tub's front seal (the long rubber seal enclosing the opening of the dishwasher). Do not touch the heating element during or immediately after use.

CLEANING THE FILTERS

1. Turn off the dishwasher.
2. Rotate the filter insert counterclockwise to unfasten and then detach the filter insert.
3. Remove the fine filter (flat, rectangular) and clean with water.
4. Replace the filters before re-using the dishwasher.

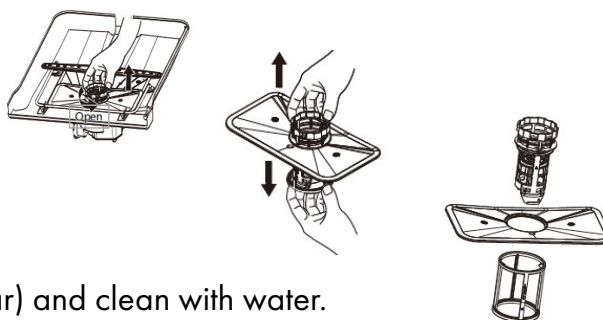

TROUBLESHOOTING

PROBLEM	POSSIBLE CAUSE	POSSIBLE SOLUTION
The dishwasher won't start	Power supply or power line is not connected	Check and connect power supply
	Delay start option has been selected	Refer to delay start section in this manual
Rinse Aid light is on	Display screen shows "LSb"	Add rinse aid
Dishwasher operates too long	The dishwasher is connected to cold water	Make sure the dishwasher is connected to hot water
	The cycle time will vary according to soil level	The cycle will increase based on soil level
	The sanitize option is selected	The cycle will increase when using sanitize
Dishes are not clean enough	Water pressure is temporarily low	Try again when water pressure is normal
	The inlet water temperature is low	Make sure hot water is connected
	Dishes are loaded too close together	Re-load dishes according to this user manual
	The selected cycle is not suitable for soil condition	Choose another cycle with a longer wash time
	Spray arms are blocked	Unblock spray arms
Dishes are not drying	Rinse aid dispenser is empty	Fill rinse aid dispenser
	Improper dish loading	Re-load dishes according to manual
	The chosen cycle does not include drying	Choose a different cycle with drying
Spots and film on dishes	Water is too hard	Install water softener
	Improper dish loading	Re-load the dishes
	Rinse aid is expired	Use fresh rinse aid
	Rinse aid dispenser empty	Add rinse aid
Etching on glasses	Too much detergent	Use less detergent
	Inlet water temp exceeds 158°F	Lower inlet water temp
Detergent left in dispenser	Detergent may be too old	Clean out the dispenser and replace with new detergent
	Spray arm is blocked	Inspect and clean the spray arm water jet holes as necessary

TROUBLESHOOTING

PROBLEM	POSSIBLE CAUSE	POSSIBLE SOLUTION
Detergent dispenser won't close	Improper operation of the detergent cover	Inspect detergent dispenser door latch for operation; if using pod or solid detergent, this may prevent the closure of the detergent dispenser door
Water remains in the dishwasher	Previous cycle has not finished or has been interrupted	Make sure the dishwasher is connected to hot water; the cycle will increase based on soil level; the cycle will increase when using sanitize
Dishwasher does not drain properly	Drain is clogged	Check the air gap if you have one; make sure disposal is empty if the dishwasher is connected to one
	Drain hose is kinked	Make sure the drain hose is properly connected to the sink
Suds in the tub	Improper detergent was used	Only use automatic dishwasher detergent
Dishwasher leaks	Improper detergent was used	Only use automatic dishwasher detergent
	Dishwasher is not level	Level the dishwasher
Black or gray marks on dishes	Aluminum utensils rubbed against dishes	Rearrange dishes and make sure water inlet is no less than 120°F
Stained tub interior	Coffee and tea soil	Use an approved spot cleaner to remove soil
	Reddish stain	Use the rinse only cycle right after loading to decrease staining
Noises	Detergent cup is open	This is normal
	A hard object entered the wash module	If noise persists, call for service
Dishwasher won't fill up	Water valve is off	Turn on water valve
	Door latch may not be properly sealed	Make sure door is closed

TROUBLESHOOTING

CODE	ERROR MESSAGE	POSSIBLE REASON
E1	During the water inlet step, if the flow meter can't detect the water after 4 minutes, the dishwasher will display an E1 warning.	<ol style="list-style-type: none"> 1. Check the water supply 2. Check the inlet valve 3. Check the inlet 4. Check the flow meter 5. Check the pressure switch 6. Check the drain 7. Check the PCB <p>See more detailed instructions on page 24.</p>
E3	(Only appears in the factory mode) When the temperature can't reach the defined temperature after 90 minutes, the dishwasher will display an E3 warning.	<ol style="list-style-type: none"> 1. Check the heater 2. Check the thermistor 3. Check the PCB
E4	When the water floods into the bottom of unit and activates the flood microswitch, the dishwasher will display an E4 warning.	<ol style="list-style-type: none"> 1. Check the use of the detergent 2. Check whether the appliance is level 3. Check the micro-switch 4. Check the drain pump 5. Clear drain hose from any obstruction 6. Check the amount of the filled water 7. Find where leakage is 8. Hard reset (turn the breaker off for 10 seconds and turn it back on) <p>OR</p> <ol style="list-style-type: none"> 1. Remove the base board 2. Remove the switch at the base board 3. Lift up the dishwasher 4. Find where the leakage is. 5. Hard reset (turn the breaker off for 10 seconds and turn it back on)

TROUBLESHOOTING

TERM	DESCRIPTION	LOCATION/APPEARANCE
Pressure switch	The pressure switch is a protection device that detects water pressure. It prevents the water level from becoming too high.	<ul style="list-style-type: none"> In the back of the dishwasher on the right. Red, white, and blue.
Flowmeter	The flowmeter calculates the amount of water flowing into the dishwasher for every inflow step.	<ul style="list-style-type: none"> Inside the breather on the side of the dishwasher. White and green.
Flooding switch (Micro-switch)	<p>The flooding switch activates the E4 Error (when the water floods into the bottom of the dishwasher and activates the flooding switch).</p> <p>NOTE: You do not need to reset the flooding switch. You only need to resolve the errors associated with it, then remove the water at the bottom of the dishwasher. The flooding switch will return to its original state.</p>	<ul style="list-style-type: none"> At the bottom cap of the dishwasher. Black, blue, and white.

CODE	ERROR MESSAGE	POSSIBLE REASON
E6	(Only appears in the factory mode)	<ol style="list-style-type: none"> Check the inlet water temperature Check the thermistor Check the PCB
E7	E6 - Thermal sensor cut. E7 - Thermal sensor short.	
E9	If one button is pushed for more than 30 seconds, the dishwasher will display an E9 warning.	The warning will be resolved when the button is released
ED	If the dashboard detects that communication data is abnormal for more than 30 seconds, the dishwasher will display an ED warning.	Communication data abnormal, warning resolved when communication data returns to normal.



If overflow occurs, turn off the main water supply before calling for service. If there is water in the base pan because of an overflow or small leak, the water should be removed before restarting the dishwasher.

TROUBLESHOOTING

E1 Longer Inlet Time

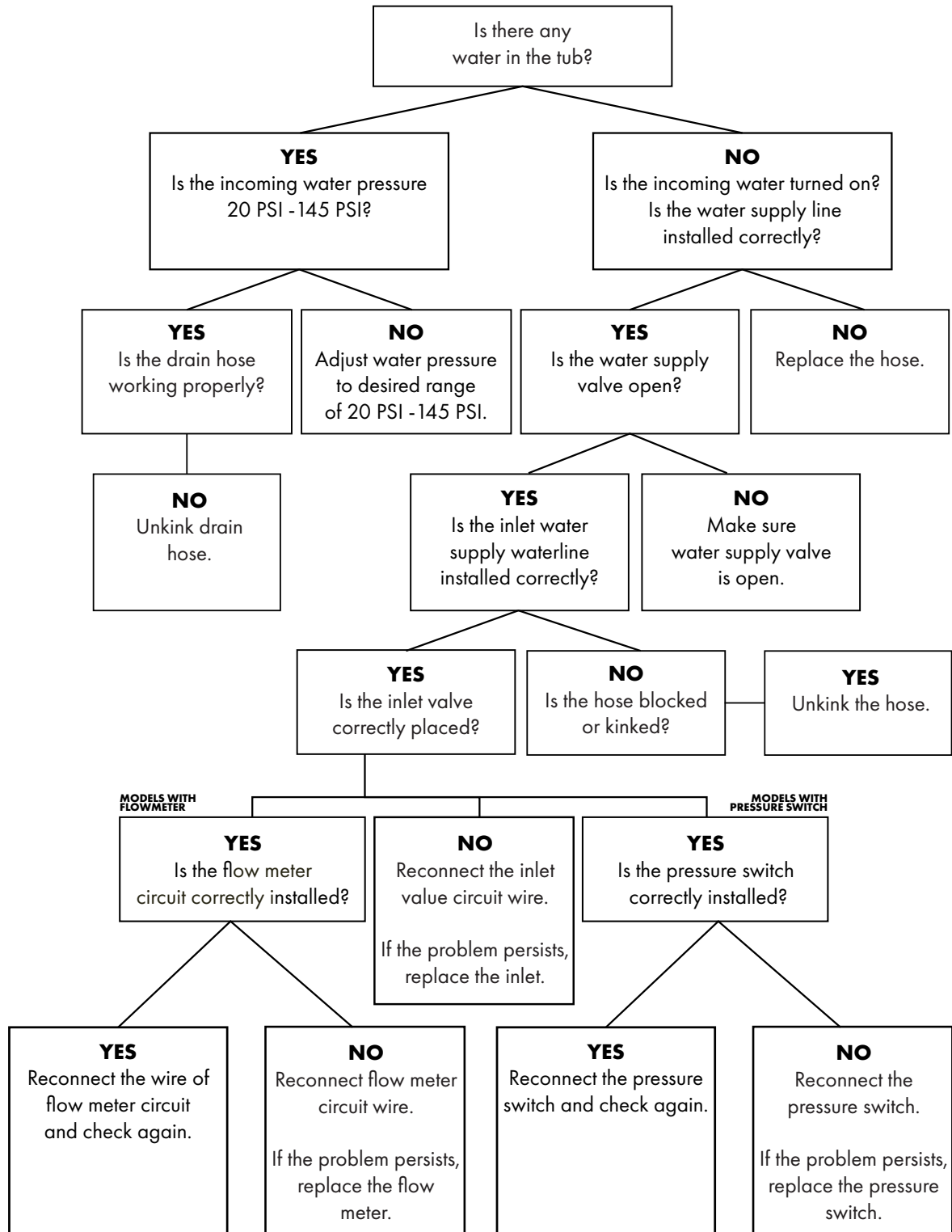

If the problem has not been solved through all the instructions mentioned above, the PCB might have a malfunction. Replace PCB and test again.

WARRANTY

COVERAGE

ZLINE Kitchen and Bath dishwasher products will be warrantied for one year from the original purchase date for the original purchaser of the product. This warranty covers all parts and labor for necessary repairs if any part of the product proves to be defective in materials or workmanship. The product must be deemed serviceable via troubleshooting with the ZLINE Kitchen and Bath service team. All service on ZLINE Kitchen and Bath dishwasher products under the above warranty must be performed by ZLINE approved and certified service, unless otherwise specified by ZLINE Kitchen and Bath. Service will be provided during normal business hours.

TERMS

This warranty applies only to the original purchaser of the product installed for normal residential use. This is defined as a single-family, residential dwelling in a non-commercial setting. Commercial settings include but are not limited to: schools, churches, hotels, restaurants, vacation rentals such as Airbnb, day care centers, private clubs, fire stations, common areas in multi-family dwellings, nursing homes, food service locations, and institutional food service locations such as hospitals or correction facilities. This warranty is non-transferable and will not be extended based on the date of installation. The warranty applies only to products installed in the continental United States and the District of Columbia.

Failure to secure certified warranty service per these terms will result in a forfeiture of the remaining warranty. Out of pocket payments will not be reimbursed unless prior approval is received from ZLINE Kitchen and Bath and/or our service contract partner. Unapproved out of pocket payments for service will not be reimbursed. All warranty procedures must be followed to maintain warranty coverage.

Warranty shall not apply and ZLINE Kitchen and Bath is not responsible for damage resulting from negligence, improper maintenance, misuse, abuse, alteration of or tampering with the appliance, accident, natural disaster, improper electric supply, unauthorized service or repair, improper installation, or installation not in accordance with the instructions contained in the manual or the local government codes.

WARRANTY



WHAT IS NOT COVERED

1. Installation or start-up damages or problems caused by improper installation or use.
2. Damage related to unauthorized service or unauthorized parts.
3. Installation in any commercial or non-residential application.
4. Aesthetic damage, scratches, or natural wear caused by normal use.
5. Second-hand, open box products, or products purchased from an unauthorized retailer.

NOTE: In the event that service is dispatched, and it is discovered that the reported issue is not covered under warranty based on the disclaimers above, the customer will be responsible for all service fees. Failure to pay these fees will result in the forfeiture of remaining warranty coverage.



The rating tag shows the model and serial number of your dishwasher. The product label and rating tag is located on the right-hand side of the inner door of the dishwasher. The tag is visible when the dishwasher door is open. Do not remove permanently affixed labels, warnings, or plates from the product. This will void the warranty.

	DISHWASHER					LISTED
	MODEL: DW7713-24					844
	SN: [REDACTED]					
VOLTAGE	120V AC	FREQUENCY	60Hz	PHASE	Single	
TOTAL AMPS	6.67A	MOTOR	0.84A	HEATER	5.83A	

WARRANTY



SERVICE

For warranty service, please contact our Customer Service team at 1-614-777-5004 or visit www.zlinekitchen.com/contact to utilize our online Customer Experience Portal.



Need to purchase a part or accessory for your ZLINE product? Visit ZLINEparts.com, ZLINE's official parts distribution partner.

2.0.0

www.zlinekitchen.com

1-614-777-5004

contact@zlinekitchen.com

ZLINE
ATTAINABLE LUXURY®