

Dimensional Document

Viega MegaPress® and MegaPress®G Fittings



This document is subject to updates. For the most current Viega technical literature please visit viega.us.



Viega products are designed to be installed by licensed and trained plumbing and mechanical professionals who are familiar with Viega products and their installation. **Installation by non-professionals may void Viega LLC's warranty.**

MegaPress 90° Elbow, Carbon Steel, P x P - Models 4816 / 6616

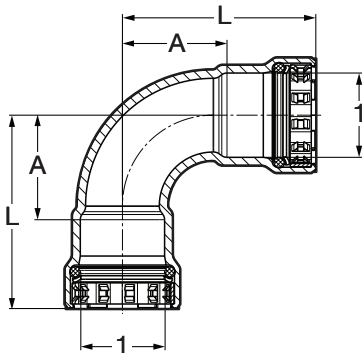

Part No.		Size (in)	A (in)	L (in)
MegaPress	MegaPressG	1		
25200	25201	1/2	1.17	2.24
25205	25206	3/4	1.36	2.52
25210	25211	1	1.72	3.07
25215	25216	1 1/4	2.00	3.82
25220	25221	1 1/2	2.26	4.13
25225	25226	2	2.80	4.78

MegaPress 90° Elbow, Carbon Steel, P x FTG - Models 4816.1 / 6616.1

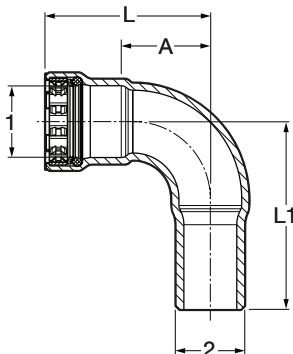

Part No.		Size (in)	A (in)	L (in)	L1 (in)
MegaPress	MegaPressG	1 2			
26050	26051	1/2 x 1/2	1.17	2.24	2.56
26055	26056	3/4 x 3/4	1.36	2.52	2.87
26060	26061	1 x 1	1.72	3.07	3.39
26065	26066	1 1/4 x 1 1/4	2.00	3.82	4.04
26070	26071	1 1/2 x 1 1/2	2.26	4.13	4.21
26075	26076	2 x 2	2.80	4.78	5.08

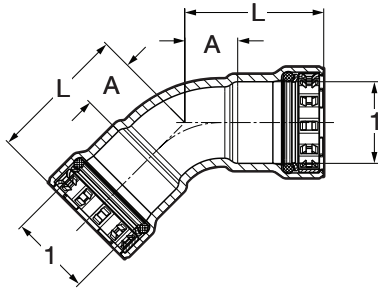
MegaPress 45° Elbow, Carbon Steel, P x P - Models 4826 / 6626

Part No.		Size (in)	A (in)	L (in)
MegaPress	MegaPressG	1		
25230	25231	1/2	0.60	1.67
25235	25236	3/4	0.71	1.87
25240	25241	1	0.86	2.20
25245	25246	1 1/4	0.98	2.80
25250	25251	1 1/2	1.12	2.99
25255	25256	2	1.32	3.31

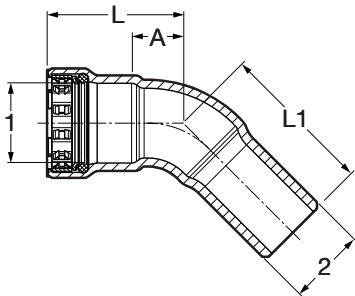
MegaPress 45° Elbow, Carbon Steel, P x FTG - Models 4826.1 / 6626.1

Part No.		Size (in)	A (in)	L (in)	L1 (in)
MegaPress	MegaPressG	1 2			
26100	26101	1/2 x 1/2	0.60	1.67	1.97
26105	26106	3/4 x 3/4	0.71	1.87	2.13
26110	26111	1 x 1	0.86	2.20	2.52
26115	26116	1 1/4 x 1 1/4	0.98	2.80	2.99
26120	26121	1 1/2 x 1 1/2	1.12	2.99	3.07
26125	26126	2 x 2	1.32	3.31	3.58

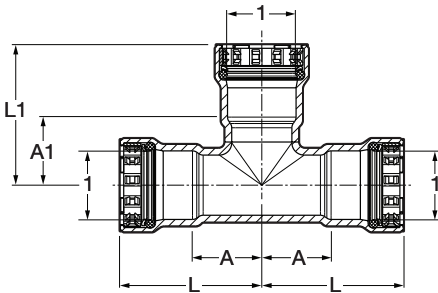
MegaPress Tee, Carbon Steel, P x P x P - Models 4818 / 6618

Part No.		Size (in)	A (in)	A1 (in)	L (in)	L1 (in)
MegaPress	MegaPressG	1				
25300	25301	1/2	0.97	0.93	2.04	2.00
25305	25306	3/4	1.11	1.09	2.26	2.24
25310	25311	1	1.23	1.23	2.57	2.57
25315	25316	1 1/4	1.41	1.38	3.23	3.20
25320	25321	1 1/2	1.57	1.54	3.44	3.41
25325	25326	2	1.81	1.80	3.80	3.79

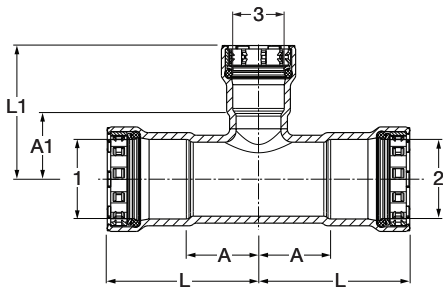
MegaPress Reducing Tee, Carbon Steel, P x P x P - Models 4818 / 6618

Part No.		Size (in)			A (in)	A1 (in)	L (in)	L1 (in)
MegaPress	MegaPressG	1	2	3				
25330	25331	¾ x ¾ x ½			1.11	1.07	2.26	2.14
25335	25336	1 x 1 x ½			1.23	1.20	2.57	2.28
25340	25341	1 x 1 x ¾			1.23	1.24	2.57	2.40
25510	25491	1¼ x 1¼ x ½			1.41	1.35	3.23	2.42
25515	25496	1¼ x 1¼ x ¾			1.41	1.39	3.23	2.55
25350	25351	1¼ x 1¼ x 1			1.41	1.38	3.23	2.73
25360	25361	1½ x 1½ x ½			1.57	1.44	3.44	2.51
25365	25366	1½ x 1½ x ¾			1.57	1.48	3.44	2.64
25370	25371	1½ x 1½ x 1			1.57	1.48	3.44	2.83
25375	25376	1½ x 1½ x 1¼			1.57	1.50	3.44	3.32
25380	25381	2 x 2 x ½			1.81	1.74	3.80	2.81
25385	25386	2 x 2 x ¾			1.81	1.80	3.80	2.95
25390	25391	2 x 2 x 1			1.81	1.75	3.80	3.10
25395	25396	2 x 2 x 1¼			1.81	1.78	3.80	3.60
25400	25401	2 x 2 x 1½			1.81	1.84	3.80	3.71

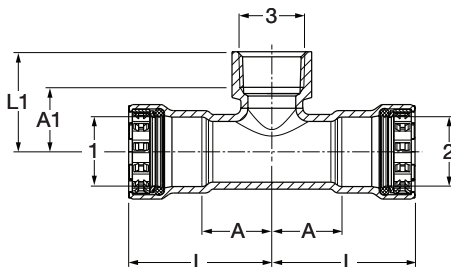
MegaPress Reducing Tee, Carbon Steel, P x P x FPT - Models 4817.2 / 6617.2

Part No.		Size (in)			A (in)	A1 (in)	L (in)	L1 (in)
MegaPress	MegaPressG	1	2	3				
25405	25406	¾ x ¾ x ½			1.11	1.02	2.26	1.55
25480	25481	¾ x ¾ x ¾			1.11	1.03	2.26	1.58
25410	25411	1 x 1 x ½			1.23	1.19	2.57	1.73
25415	25416	1 x 1 x ¾			1.23	1.18	2.57	1.73
25485	25486	1¼ x 1¼ x ½			1.41	1.31	3.23	1.85
25505	25506	1¼ x 1¼ x ¾			1.41	1.33	3.23	1.89
25500	25501	1¼ x 1¼ x 1			1.41	1.37	3.23	2.03
25435	25436	1½ x 1½ x ½			1.57	1.42	3.44	1.95
25440	25441	1½ x 1½ x ¾			1.57	1.41	3.44	1.97
25445	25446	1½ x 1½ x 1			1.57	1.57	3.44	2.24
25450	25451	1½ x 1½ x 1¼			1.57	1.47	3.44	2.15
25455	25456	2 x 2 x ½			1.81	1.70	3.80	2.24
25460	25461	2 x 2 x ¾			1.81	1.72	3.80	2.28
25465	25466	2 x 2 x 1			1.81	1.89	3.80	2.55
25470	25471	2 x 2 x 1¼			1.81	1.77	3.80	2.45
25475	25476	2 x 2 x 1½			1.81	1.73	3.80	2.41

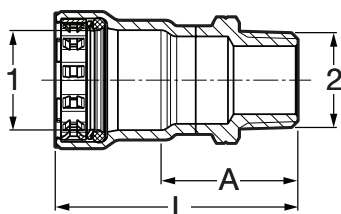
MegaPress Adapter, Carbon Steel, P x MPT - Models 4811 / 6611

Part No.		Size (in)		A (in)	L (in)
MegaPress	MegaPressG	1	2		
25100	25101	½ x ½		1.45	2.52
25105	25106	¾ x ¾		1.50	2.66
25110	25111	1 x 1		1.66	3.00
25115	25116	1¼ x 1¼		1.90	3.70
25120	25121	1½ x 1½		1.93	3.80
25125	25126	2 x 2		1.93	3.92

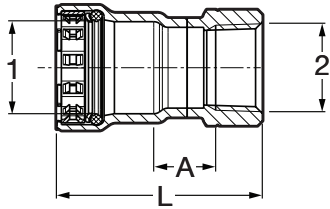
MegaPress Adapter, Carbon Steel, P x FPT - Models 4812 / 6612

Part No.		Size (in)		A (in)	L (in)
MegaPress	MegaPressG	1	2		
25130	25131	1/2	1/2	0.69	2.29
25135	25136	3/4	3/4	0.74	2.45
25140	25141	1	1	0.73	2.74
25145	25146	1 1/4	1 1/4	0.77	3.27
25150	25151	1 1/2	1 1/2	0.72	3.28
25155	25156	2	2	0.76	3.44

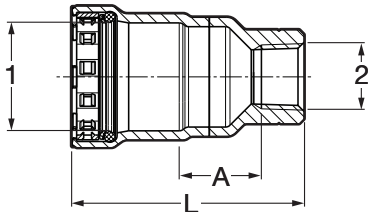
MegaPress Reducing Adapter, Carbon Steel, P x FPT - Models 4812 / 6612

Part No.		Size (in)		A (in)	L (in)
MegaPress	MegaPressG	1	2		
25575	25576	3/4	1/2	0.73	2.43
25580	25581	1	1/2	1.03	2.91
25585	25586	1	3/4	0.78	2.68
25590	25591	1 1/4	1/2	1.15	3.50
25595	25596	1 1/4	3/4	1.11	3.48
25600	25601	1 1/4	1	0.76	3.24
25605	25606	1 1/2	1/2	1.31	3.72
25610	25611	1 1/2	3/4	1.27	3.70
25615	25616	1 1/2	1	1.11	3.64
25620	25621	1 1/2	1 1/4	0.86	3.41
25625	25626	2	1/2	1.56	4.06
25630	25631	2	3/4	1.54	4.08
25635	25636	2	1	1.35	4.00
25640	25641	2	1 1/4	1.28	3.93
25645	25646	2	1 1/2	1.03	3.70

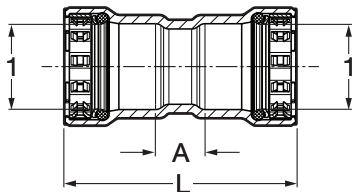
MegaPress Coupling with Stop, Carbon Steel, P x P - Models 4815 / 6615

Part No.		Size (in)	A (in)	L (in)
MegaPress	MegaPressG	1		
25000	25001	1/2	0.56	2.70
22005	22009	3/4	0.63	2.94
25010	25011	1	0.59	3.29
25015	25016	1 1/4	0.70	4.34
25020	25021	1 1/2	0.89	4.63
25025	25026	2	0.77	4.75

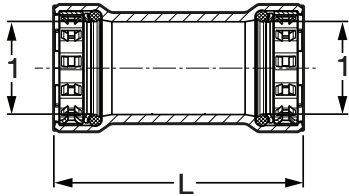
MegaPress Coupling No Stop, Carbon Steel, P x P - Models 4815.5 / 6615.5

Part No.		Size (in)	L (in)
MegaPress	MegaPressG	1	
25030	25031	1/2	2.71
25035	25036	3/4	2.94
25040	25041	1	3.29
25045	25046	1 1/4	4.34
25050	25051	1 1/2	4.63
25055	25056	2	4.74

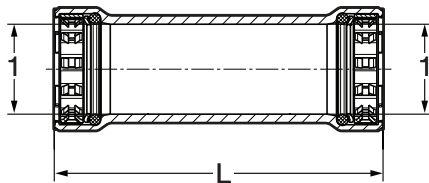
MegaPress Extended No Stop Coupling, Carbon Steel, P x P - Models 4815.3 / 6615.3

Part No.		Size (in)	L (in)
MegaPress	MegaPressG	1	
25070	25071	1/2	3.82
25075	25076	3/4	4.00
25080	25081	1	4.38
25085	25086	1 1/4	5.33
25090	25091	1 1/2	5.44
25095	25096	2	5.63

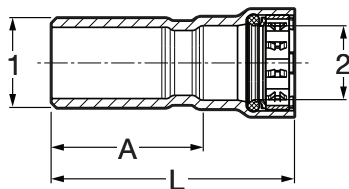
MegaPress Reducer, Carbon Steel, FTG x P - Models 4815.1 / 6615.1

Part No.		Size (in)	A (in)	L (in)
MegaPress	MegaPressG	1 2		
26000	26001	3/4 x 1/2	1.78	2.85
26005	26006	1 x 1/2	2.14	3.21
26010	26011	1 x 3/4	2.09	3.24
26015	26016	1 1/4 x 1	2.63	3.98
26020	26021	1 1/2 x 3/4	2.98	4.13
26025	26031	1 1/2 x 1	2.81	4.16
26030	26026	1 1/2 x 1 1/4	2.70	4.52
26035	26036	2 x 1	3.14	4.49
26040	26041	2 x 1 1/4	3.02	4.83
26045	26046	2 x 1 1/2	2.96	4.83

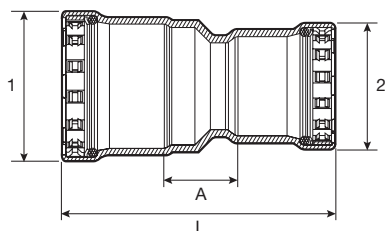
MegaPress Reducer, Carbon Steel, P x P - Models 4815.2 / 6615.2

Part No.		Size (in)	A (in)	L (in)
MegaPress	MegaPressG	1 2		
25930	25931	3/4 x 1/2	1.20	3.43
25935	25936	1 x 1/2	1.37	3.79
25940	25941	1 x 3/4	1.24	3.74
25945	25946	1 1/4 x 3/4	1.40	4.37
25950	25951	1 1/4 x 1	1.23	4.39
25955	25956	1 1/2 x 1 1/4	1.21	4.90
25960	25961	2 x 1 1/4	1.45	5.27
25965	25966	2 x 1 1/2	1.43	5.26

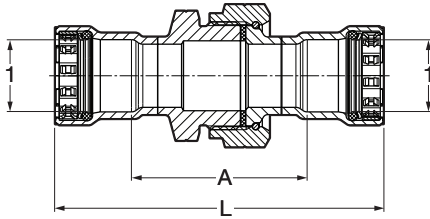
MegaPress Union, Carbon Steel, P x P - Model 4860

Part No. MegaPress	Size (in) 1	A (in)	L (in)
25700	1/2	2.35	4.50
25705	3/4	2.67	4.99
25710	1	2.65	5.34
25715	1 1/4	2.84	6.48
25720	1 1/2	2.89	6.63
25725	2	3.92	7.89

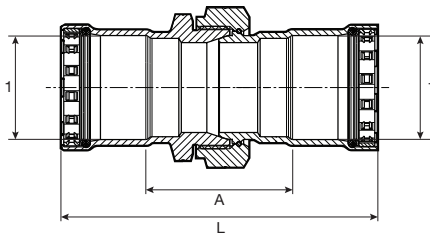
MegaPress Union, Carbon Steel, P x P - Model 6660

Part No. MegaPressG	Size (in) 1	A (in)	L (in)
25701	1/2	2.33	4.47
25706	3/4	2.67	4.98
25711	1	2.60	5.29
25716	1 1/4	2.85	6.49
25721	1 1/2	2.90	6.64
25726	2	3.41	7.35

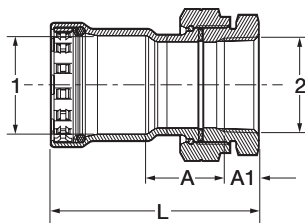
MegaPress Union, Carbon Steel, P x FPT - Model 4862

Part No. MegaPress	Size (in) 1 2	A (in)	A1 (in)	L (in)
25650	1/2 x 1/2	1.25	0.54	2.85
25655	3/4 x 3/4	1.48	0.56	3.20
25660	1 x 1	1.37	0.66	3.38
25665	1 1/4 x 1 1/4	1.53	0.68	4.03
25670	1 1/2 x 1 1/2	1.55	0.68	4.10
25675	2 x 2	2.33	0.70	5.00

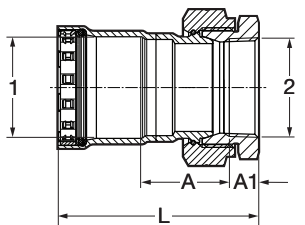
MegaPress Union, Carbon Steel, P x FPT - Model 6662

Part No. MegaPressG	Size (in) 1 2	A (in)	A1 (in)	L (in)
25651	1/2 x 1/2	1.38	0.54	2.98
25656	3/4 x 3/4	1.64	0.56	3.35
25661	1 x 1	1.62	0.66	3.63
25666	1 1/4 x 1 1/4	1.85	0.68	4.35
25671	1 1/2 x 1 1/2	1.80	0.68	4.35
25676	2 x 2	2.11	0.70	4.77

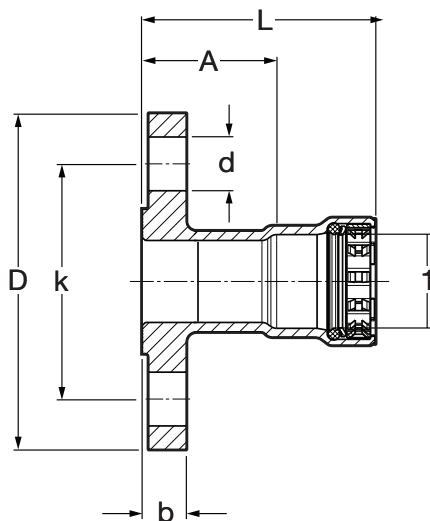
MegaPress Flange, Carbon Steel, P x BP - Models 4859.5 / 6659.5

Part No.		Size (in)	A (in)	L (in)	b (in)	k (in)	D (in)	d (in)
MegaPress	MegaPressG	1						
25760	25761	1/2	1.51	2.58	0.46	2.36	3.54	0.63
25765	25766	3/4	1.58	2.74	0.52	2.76	3.94	0.63
25770	25771	1	1.75	3.10	0.58	3.11	4.33	0.63
25775	25776	1 1/4	1.89	3.71	0.64	3.50	4.53	0.63
25780	25781	1 1/2	2.06	3.93	0.70	3.86	4.92	0.63
25785	25786	2	2.07	4.06	0.77	4.76	5.91	0.75

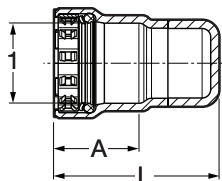
MegaPress Cap, Carbon Steel, P x Cap - Models 4856 / 6656

Part No.		Size (in)	A (in)	L (in)
MegaPress	MegaPressG	1		
25730	25731	1/2	1.07	2.14
25735	25736	3/4	1.16	2.26
25740	25741	1	1.35	2.43
25745	25746	1 1/4	1.82	2.93
25750	25751	1 1/2	1.87	3.02
25755	25756	2	1.99	3.11

MegaPress 3-Piece Ball Valve, Carbon Steel, P x P - Models 4875.8 / 5975.8

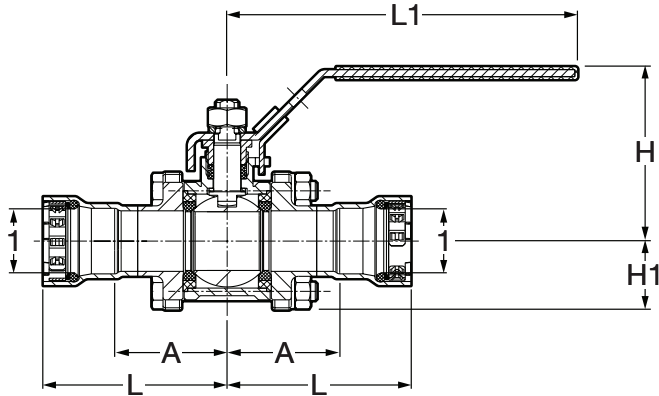

Part No.		Size (in)	A (in)	L (in)	L1 (in)	H (in)	H1 (in)
MegaPress	MegaPress FKM	1					
28500	86400	1/2	1.72	2.80	5.88	2.85	1.04
28501	86405	3/4	1.91	3.06	5.88	2.93	1.16
28502	86410	1	2.19	3.54	7.54	3.33	1.40
28503	86415	1 1/4	2.50	4.31	7.54	3.57	1.57
28504	86420	1 1/2	2.92	4.79	7.54	3.89	1.83
28505	86425	2	3.09	5.07	7.54	3.89	1.83

V Viega LLC
585 Interlocken Blvd.
Broomfield, CO 80021

Phone (800) 976-9819
www.viega.us

DD-MP 0919 MegaPress and MegaPressG Fittings

