

LED Linear Pendant

LP45560-UNV

INSTALLATION SHEET

START FROM HERE

- Make sure **POWER** is **COMPLETELY OFF** at the fuse box
- Have your fixture installed by a qualified licensed electrician
- Prepare everything in a clear area
- Wear gloves at all time during this installation
- Read instructions carefully before you start assembly
- Keep this installation sheet for future reference

Technical Support: 1-855-855-8926

Please Note:

- This Kuzco LED fixture comes with pre-wired LED module(s)
- Unless instructed, Do Not touch any part of the LED module(s) as any unnecessary contact with the module could cause permanent damage
- Use ELV (Electronic Low Voltage) or TRIAC type of dimmer for dimming application
- 120-277V input

1. Remove the fixture from its original packaging
2. Separate the mounting plate (1c) from the canopy (2a) by removing the canopy screws (2b)
3. Attach the mounting plate (1c) to the electrical junction box (1a) using junction box screws (1e) provided in the hardware package
4. Secure mounting plate (1c) to mounting surface with anchors (1f) and screws (1g)
5. Make proper electrical connections (**black to hot "L"**, **white to neutral "N"**, **ground to "GND"**) with wire nuts (1b) provided in hardware package and place driver (4a) in canopy (2a)
6. Attach canopy (2a) to mounting plate (1c) with canopy screws (2b)
7. Mark and install ceiling anchors (3b) with screw (3a) and anchor (3c), opening on ceiling anchor (3b) facing towards canopy (2a). Ideal distance between ceiling anchors (3b) is L58-11/16" and W3-15/16" (See Illustration 1)
8. Place wire onto pulley (3g), insert into ceiling anchor (3b) and secure with screw (3f)
9. Fine tune wire length if necessary, by push and hold wire gripper (2g) and then adjust wire to desired length

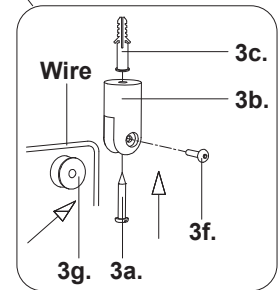
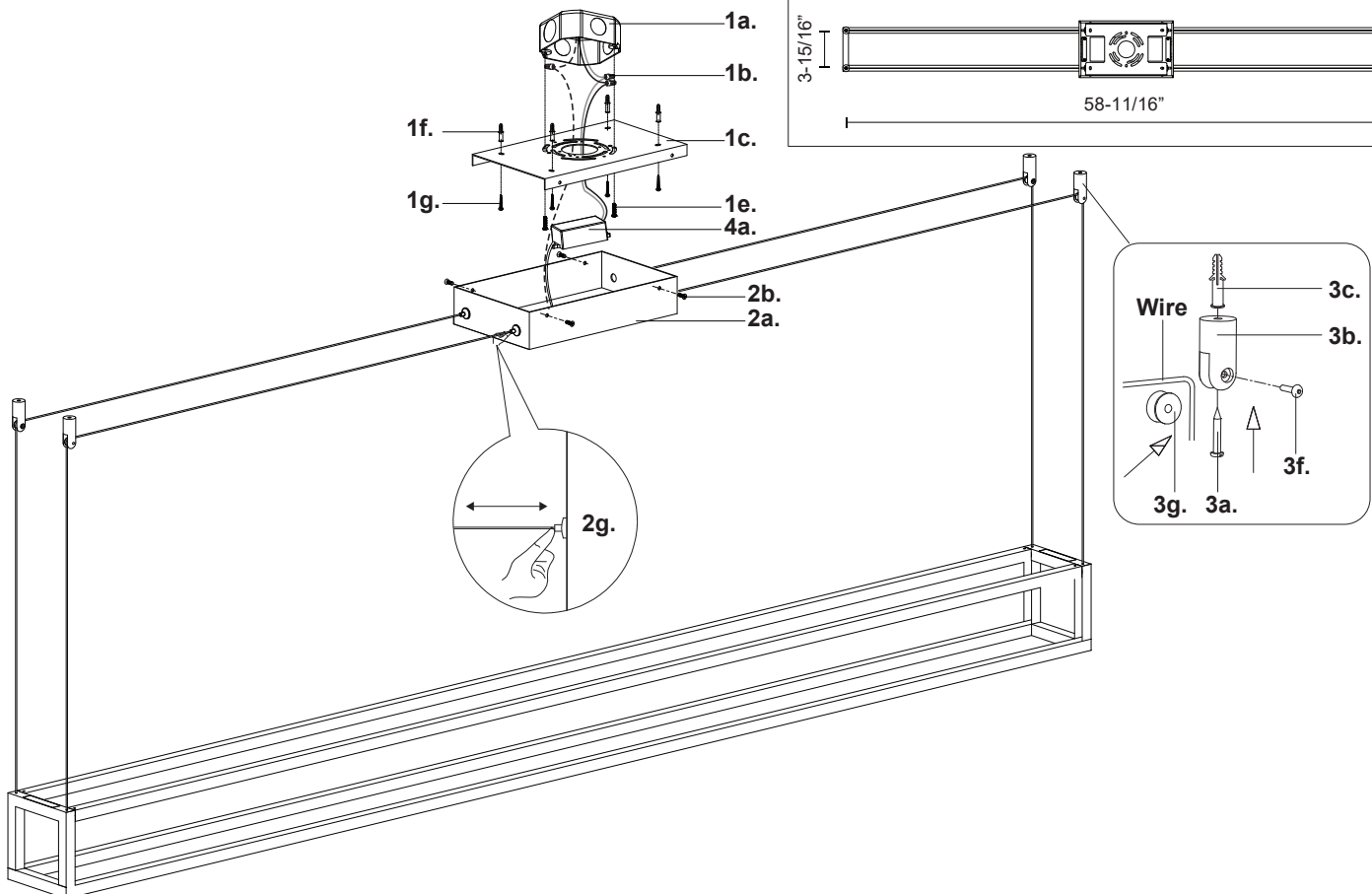
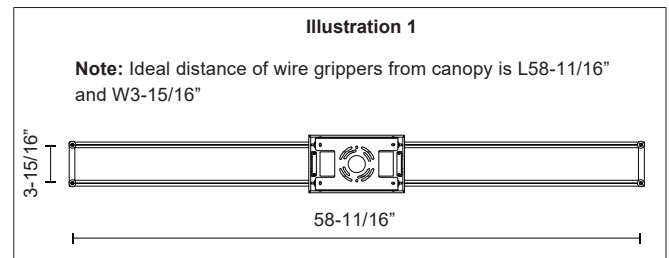

KUZCO

19054 28th Avenue Surrey, BC Canada V3Z 6M3
T: 604 538 7162 TF: 1-855 85 KUZCO F: 604 538 7196
W: kuzcolighting.com
20230314