

Features

- 8-inch center faucet holes.
- Oval basin.
- Overflow drain.
- Coordinates with other products in the Serif collection.

Material

- Vitreous china.

Installation

- Drop-in

Recommended Products/Accessories

K-8998 P-Trap



ADA CSA B651 OBC

Codes/Standards







ASME A112.19.2/CSA B45.1
ADA
ICC/ANSI A117.1
CSA B651
OBC

KOHLER® One-Year Limited Warranty

See website for detailed warranty information.

Available Colors/Finishes

Color tiles intended for reference only.

Color	Code	Description
	0	White
	96	Biscuit
	47	Almond
	NY	Dune
	95	Ice™ Grey
	G9	Sandbar
	7	Black Black™

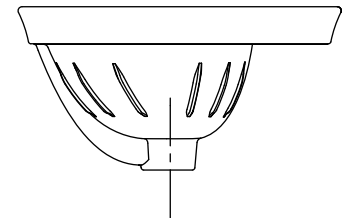
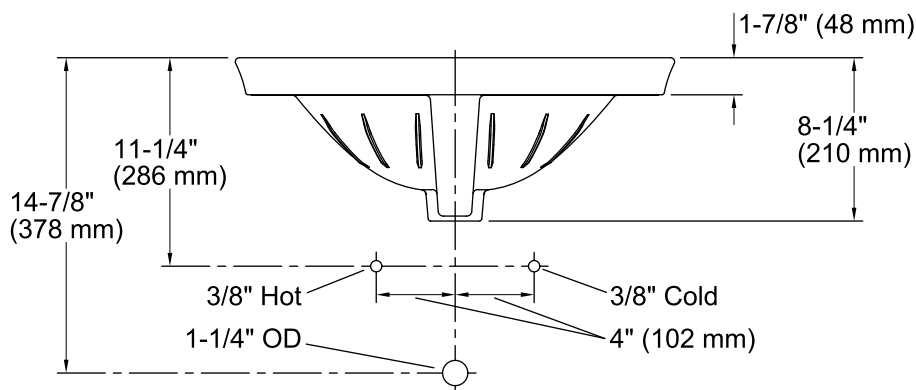
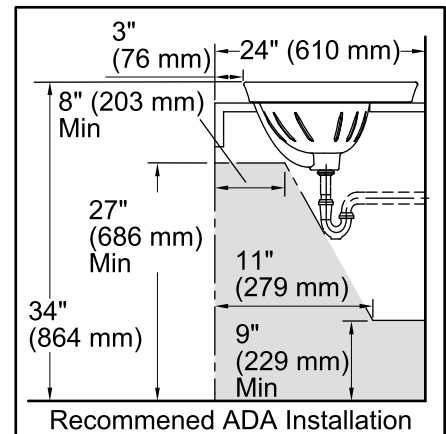
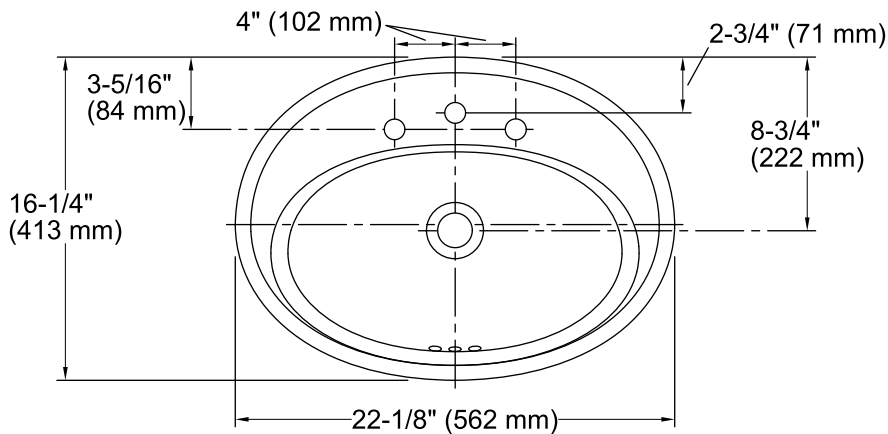

Technical Information

All product dimensions are nominal.

Bowl configuration:	Single
Installation:	Drop-in
Bowl area (Only):	Length: 16-7/8" (429 mm) Width: 10-1/8" (257 mm) Water depth: 4-7/8" (124 mm)
Number of deck holes:	1
Faucet hole spacing:	8" (203 mm)
Faucet hole(s):	1-3/8" (35 mm)
Drain hole:	1-3/4" (44 mm)
Template:	1014189-7, required, included

Notes

Install this product according to the installation instructions.

NOTICE: Countertop manufacturer or cutter must use the cut-out template provided with the product, or a current one provided by Kohler Co. (call 1-800-4-KOHLER). Kohler Co. is not responsible for cutout errors when the incorrect cut-out template is used.

ADA, OBC, CSA B651 compliant when installed to the specific requirements of these regulations.