

**DESIGN COPYRIGHT – 10/13/2022**  
 ALL RIGHTS RESERVED AND MAY  
 NOT BE DUPLICATED WITHOUT OUR  
 WRITTEN PERMISSION

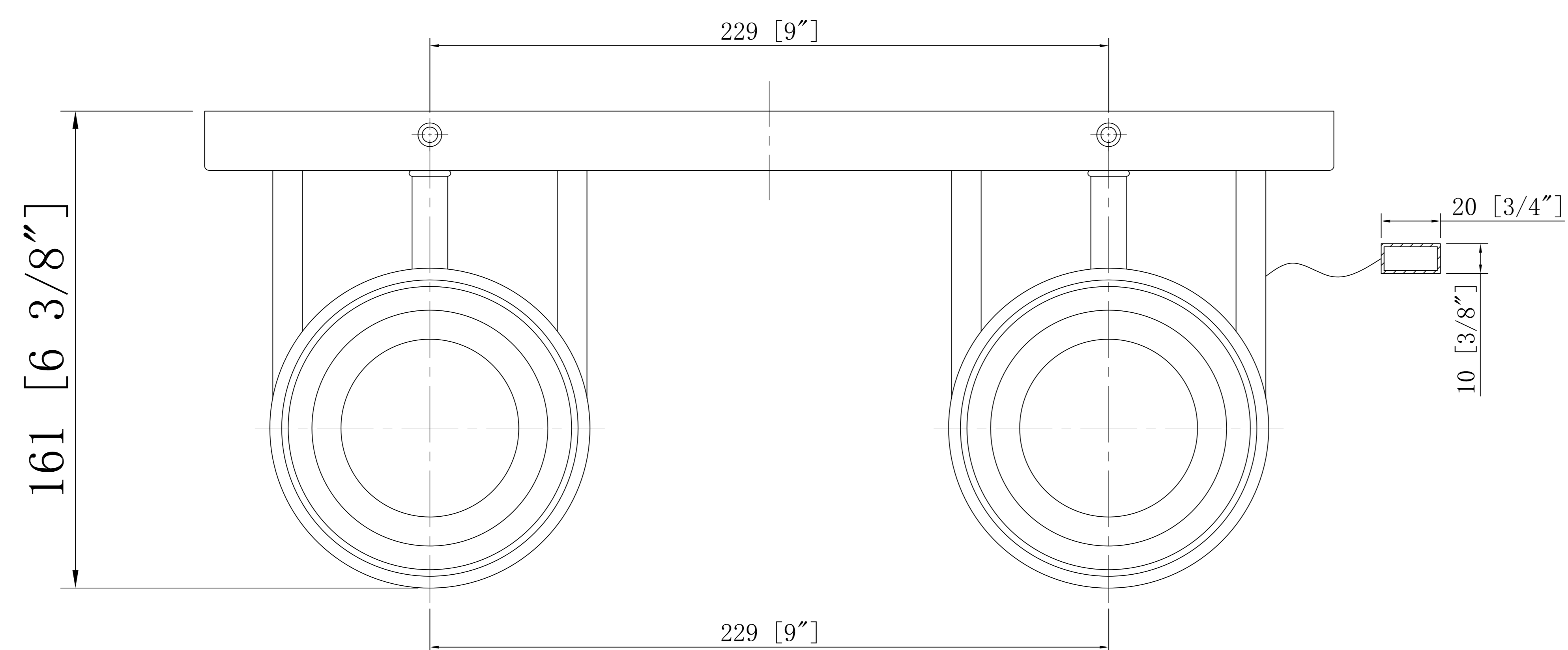
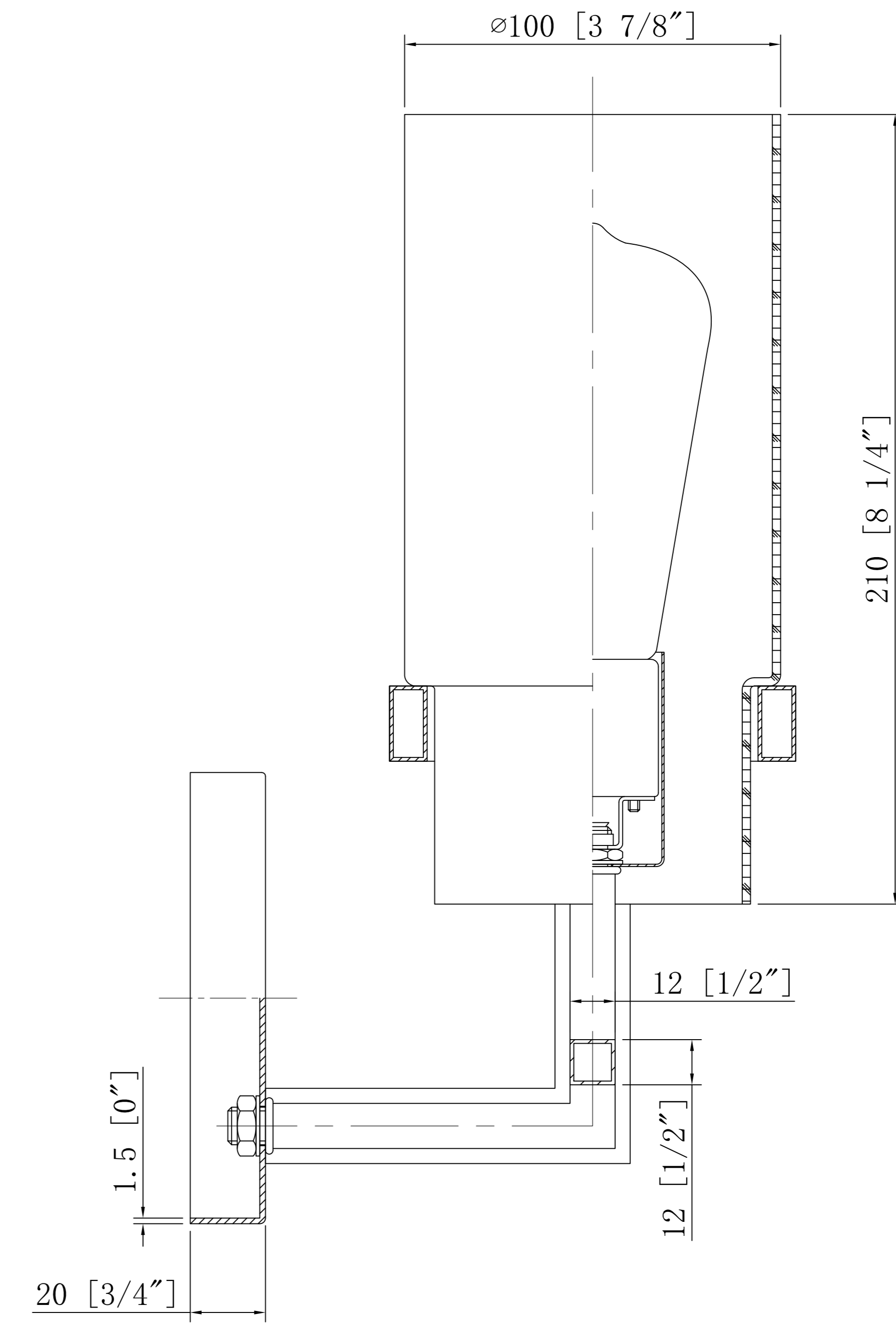
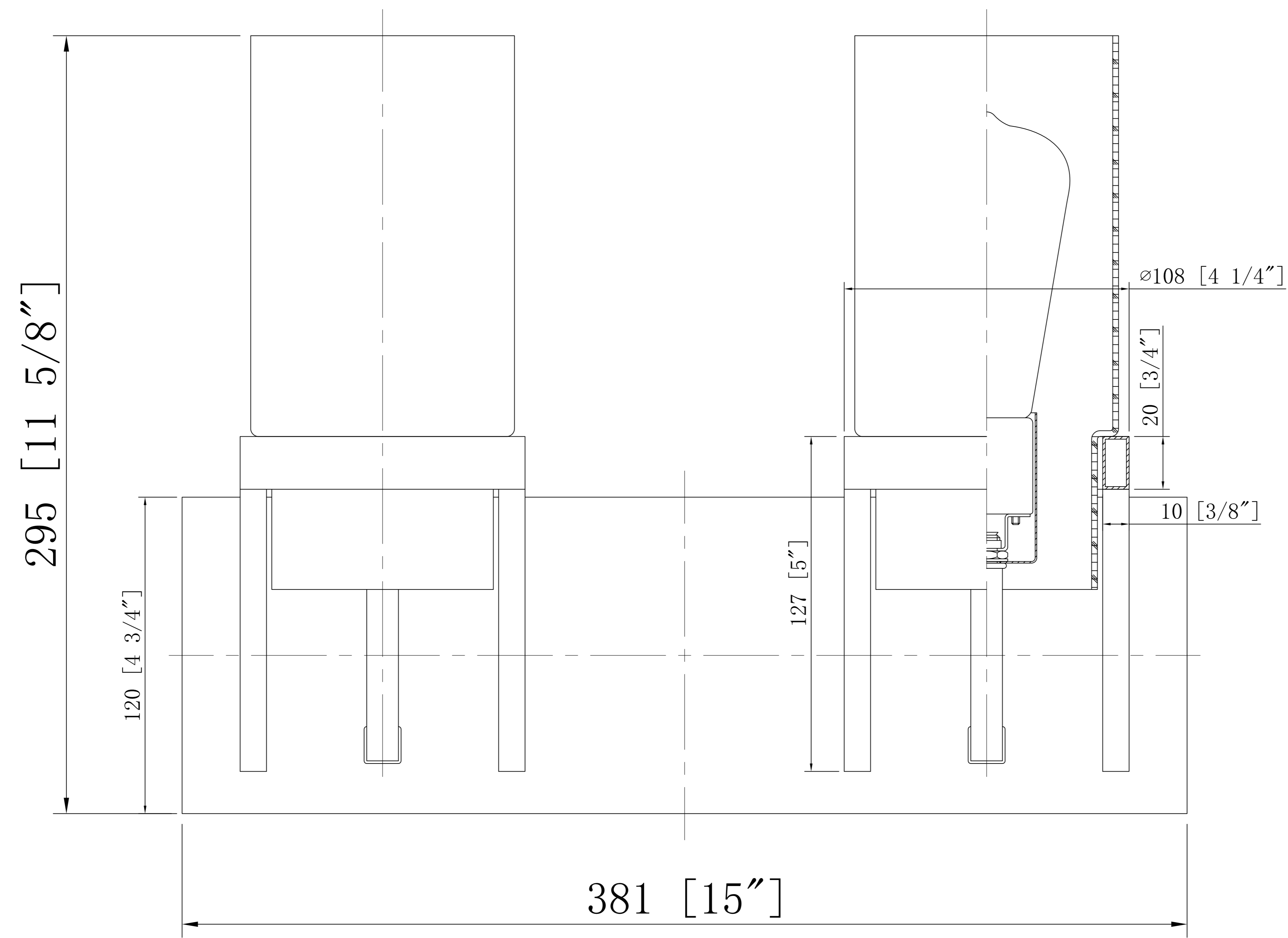
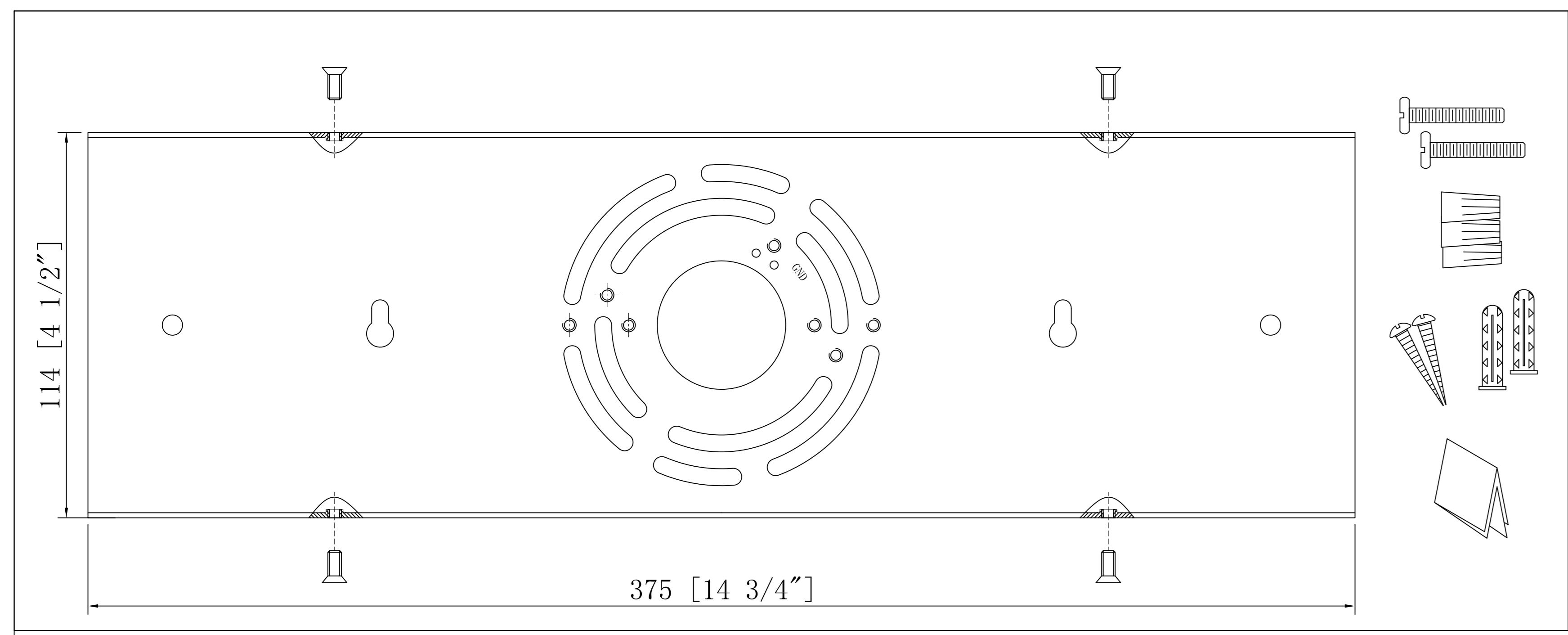

**ITEM: 426-2W**