

LUXURY ACRYLIC SERIES

SUBMITTAL DATA

TOP VIEW

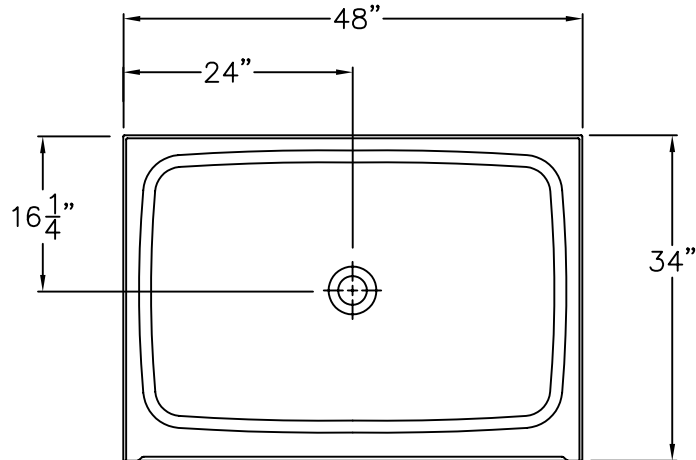

FRONT VIEW

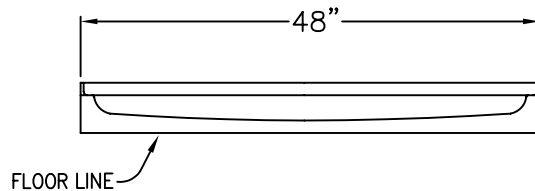

SIDE VIEW

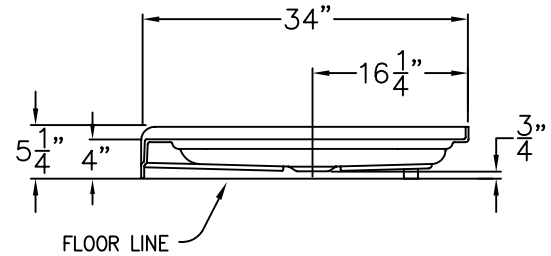

AB 3448 ACRYLIC SHOWER PAN. UNIT MEASURES 48" x 34" x 5 1/4"
WITH A THRESHOLD HEIGHT OF 4".

DUE TO THE NATURE OF THE MATERIALS
DIMENSIONS MAY VARY ± 1/2"

Job Name:	AQUARIUS	
Model No.:	Drawing#: AB 3448 ACRYLIC PAN	
Approved by:	Date Approved:	Date: 5-1-08 Revised: 6-18-10
Rep.:	Wholesaler:	Quote No.:

PRAXIS INDUSTRIES, INC.
ROUTE 1, BOX 46D - SAVANNAH, TN 38372
1 (800) 443-7269 - FAX (901) 925-4290