

Assembly Instructions: 0306-BA3

IMPORTANT:

- ALL INSTALLATION WORK SHOULD BE DONE BY ACCREDITED PROFESSIONAL.
- SHUT OFF POWER SUPPLY AT FUSE OR CIRCUIT BREAKER!
- USE ONLY THE SPECIFIED BULBS. DO NOT EXCEED THE MAXIMUM WATTAGE!

For Customer Service, please contact the place of purchase.

PREPARING FOR INSTALLATION

Remove all of the contents from the carton. See the important notes above. Shut off the power at the circuit breaker and completely remove the old fixture from the wall, including the old mounting strap.

1. Mounting strap (B) may be attached to backplate (F). If so, unscrew backplate screws (A) and place the screws to the side for future use. Find the pair of holes on mounting strap (B) that matches the spacing of the holes on the junction box and the fixture's backplate (F).
2. Line up the holes in backplate (F) with the holes in mounting strap (B) to test before inserting mounting screws (D) through mounting strap (B) to secure mounting strap (B) to the junction box.
3. Pull the house wires through the center of mounting strap (B). Tighten mounting screws (D) securely.

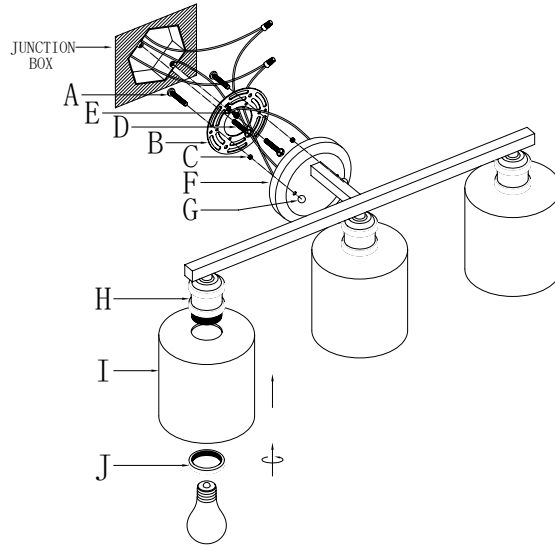

CONNECTING THE WIRES

4. Have an assistant support the weight of the fixture during the wiring process. Attach the fixture's wires to the power supply wires from the junction box. Connect black to black (or smooth); white to white (or ribbed); ground to ground (green or copper). Twist the ends of the wire pairs together, then twist on a wire connector. Make sure all twists are in the same direction. If there is no ground wire (green or copper) from the junction box, locate ground screw (E) and wrap the fixture's ground wire around the green ground screw (E). Use a screwdriver to secure ground screw (E) onto the mounting bracket. Tuck all wires neatly into the junction box.

How to Identify the Fixture's Wires		
Hot	Neutral	Ground
Smooth	Ribbed	Bare Metal, Green, or Green Inner Thread
Black	White	
Black Inner Thread	White Inner Thread	

FINISHING THE INSTALLATION

5. Place the fixture's backplate (F) over mounting strap (B) so that the holes in backplate (F) match up with the holes mounting strap (B). Thread nuts (G) onto the exposed threads of mounting screws (A) to secure backplate (F) to mounting strap (B). Twist until the backplate is snug against the wall, but be careful not to scratch the fixture.
6. Carefully slide glass shades (I) over sockets (H) and secure in place with socket rings (J).
7. Install light bulbs (not provided) in accordance with the fixture's specifications. Do not exceed the maximum recommended wattage in the specifications.

Your installation is now complete. Turn on the power and test the fixture.

CLEANING TIPS

Treat the fixture gently! Regular cleaning will reduce the need for deep cleaning. For regular cleaning, turn off the light and wipe down the fixture with a clean lint-free cotton or microfiber cloth. Never spray cleaner directly onto the fixture.